



Kalzip Ltd

Kalzip® systems

Products and applications



Kalzip

Innovative performance and proven system solutions for creative architectural design





Project: Qizhong International
Tennis Centre, China
Architect: Environment Design Institute
(EDI Tokyo) and Shanghai Modern
Architectural Design Institute

Contents

Product introduction	4	Rooflights	42
Profiles	7	Materials and finishes	46
Roll forming technology and Kalzip XT	8	System design and performance	50
System configurations		Curves and tapers	52
Liner roof system	10	Long length sheets	54
Structural deck system	12	Thermal performance – U-value tables	56
Liner deck system	16	Structural performance – load span tables	60
Low U-value system	18	Material characteristics	64
System variations	19	Kalzip as a lightning conductor	65
Acoustic build	20	On-site requirements	66
Kalzip sustainable solutions		Technical services and support	67
Nature Roof	22	Kalzip international and project gallery	68
Solar solutions	24		
Components and accessories	28		
Clips	30		
Seam clips	34		
Vapour control layer	34		
Insulation	35		
Fall arrest and walkway systems	36		
Fabrications	38		



Project: Reading University, Berkshire, UK
Architect: BDP

Innovation is our strength

Our research and development work is based on one aim: to provide the very best solutions every time

Kalzip can transform ideas into reality, without any compromise on quality and with a true passion for detail.

Kalzip aluminium standing seam profiles are able to meet the most demanding construction and design requirements to create roofs and facades that successfully combine outstanding functionality with stunning aesthetics. The design potential is virtually limitless – from the discreet to the elaborate; combining sophisticated elegance with contemporary design. Truly sustainable features such as Kalzip Solar Solutions or the Kalzip Nature Roof provide the perfect finishing touches to the unique Kalzip range.

Benefits

- perfect system solutions
- limitless design potential
- state-of-the-art production technology
- highly sophisticated, light weight building system
- ultimate product quality
- innovative material combinations
- harmonious integration of shapes, colours and surfaces
- dedicated network of approved installers

For more than 40 years Kalzip has remained at the very forefront of architectural design, constantly pushing the boundaries of creative potential. The experience gained over many years, together with our highly-specialised technical expertise, guarantees the ultimate in quality and reliability – right down to the very last detail.

The Kalzip roof system in its entirety has successfully achieved third party certification by the BBA in the UK and is globally recognised by the German Zulassung, French Avis Technique and Factory Mutual quality standards.



INVESTOR IN PEOPLE



APPROVED



Kalzip – the sophisticated, lightweight building system

Highly flexible and can be precisely tailored to suit the individual requirements of the building

Unlimited application potential

- Suitable for warm and cold roof constructions in all shapes and pitches from 1.5°, catering for all types of supporting structures.
- Can be flexibly adjusted to suit the layout, geometry and dimensions of any building.
- Extremely strong and lightweight.
- Ideal for large spans and renovating old roofs.
- Continuous lengths of 150 metres and more, when production takes place on-site.

Superior thermal and acoustic insulation

- By choosing the appropriate thickness of insulating material, the roof structure can be adapted to suit the precise requirements of the building.
- Highly efficient thermal performance can be achieved by means of constructive measures helping minimise whole life cycle costs and achieve U-values of 0.10 W/m²K and below.
- A series of acoustic tests and appreciation of the demanding requirements for noise control within buildings helps to create optimum internal conditions.

A high level of safety throughout the entire service life

- A non-penetrative patented clip attaches the sheets to the substructure. These clips are locked into the seam to ensure smooth thermal cycling of the external sheet over the clip head whilst facilitating outstanding spanning capacity under high wind loading.
- The mechanical zipping of the seams produces a load bearing, permanent connection.
- Pressure and suction loads are safely absorbed.
- The weather tight seam permits any residual moisture in the insulating layer to evaporate through the seam allowing the roof to breathe naturally.
- Sophisticated detailed solutions for roof penetrations, joints and gable ends.
- Non-flammable. Resistant to flying sparks and radiant heat.
- Kalzip aluminium sheets can be used as a lightning conductor in accordance with International Standard ENV 61024-1.

Durability and economy

- Highly resistant to corrosion.
- Non-sensitive to UV rays, resistant to micro-organisms and 'ageing'.

Valuable ecological and sustainable properties

- The raw material that contains aluminium - bauxite - is the third most commonly occurring element in the earth's crust with at least 300 years of current reserves left at the present rates of usage – a figure that is improved by the increasing amount of aluminium that is being recycled.
- Over 60% of all aluminium is produced using hydroelectric power, which is clean, CO₂ free and renewable.
- Aluminium is a closed loop process; once produced - it can be recycled infinitely with no loss of performance.
- Kalzip is a fully demountable system which, at the end of the buildings life, can be unzipped and reused or recycled without limitation.
- Up to 95% of the energy required to manufacture the original aluminium material is saved through recycling.
- A study by Delft University, supported by the European Aluminium Association through the Aluminium for Future Generations programme, found that the general collection rates of aluminium from individual buildings was between 93 and 98 per cent – almost total recovery.
- An insulated Kalzip roof structure contributes significantly to emissions reduction.



Project: Pendle Vale College, Nelson, UK
Architect: Catalyst Lend Lease



Project: Swindon Academy, Manchester, UK
Architect: Aedas Architects



Project: Birmingham New Hospital, UK
Architect: BDP

Available shapes

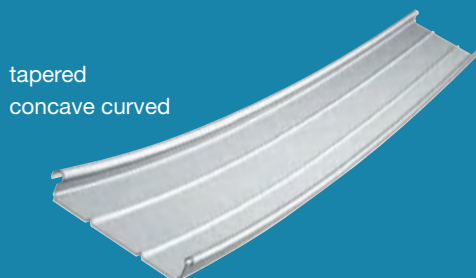
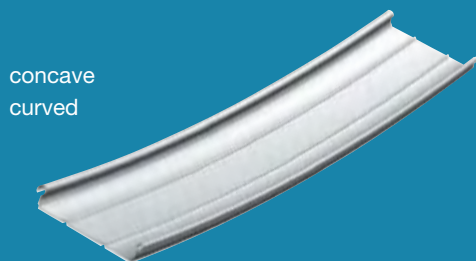
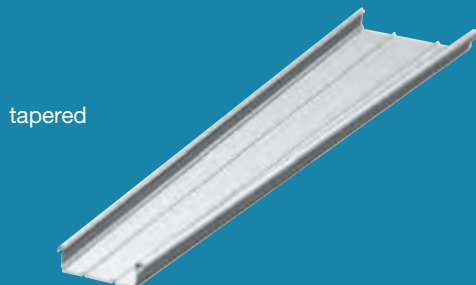
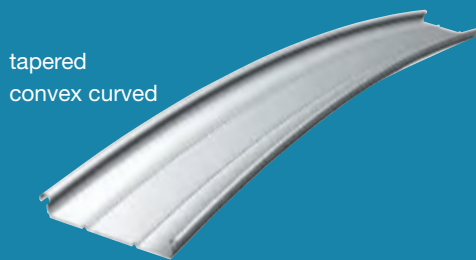
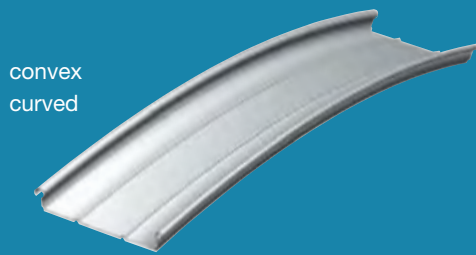
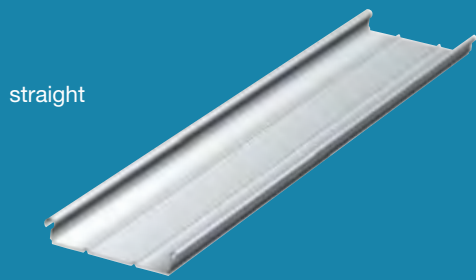

Widths of Kalzip profiled sheets

Kalzip dimensions	Thickness (mm)	Weight (kg/m ²)
Kalzip 50/333	1.2	4.666
	1.0	3.904
	0.9	3.514
Kalzip 50/429	1.2	4.375
	1.0	3.671
	0.9	3.304
Kalzip 65/305	1.2	5.094
	1.0	4.263
	0.9	3.837
Kalzip 65/333	1.2	4.940
	1.0	4.133
	0.9	3.720
	0.8	
Kalzip 65/400	1.2	4.692
	1.0	3.937
	0.9	3.543
Kalzip 65/500	1.2	4.419
	1.0	3.710
	0.9	3.339
Kalzip AF 65/333	1.2	4.666
	1.0	3.904
	0.9	3.514
Kalzip AF 65/434	1.2	4.324
	1.0	3.629
	0.9	3.266

An additional profile Kalzip AF 65/537 also exists specifically for AluPlusSolar. This 1mm thick product coated in polyester or PVdF can only be used by prior agreement with the Kalzip technical department.

Minimum roof pitch

Continuous sheet ridge to eaves	1.5° *
Continuous sheet eaves to eaves	1.5° *
Welded lap joints	1.5°
Welded roof penetrations	1.5°
Mastic and rivet sealed lap joints	3°
Mastic and rivet sealed roof penetrations	3°

* Minimum pitch requirement of 1.5° must be maintained at sheet ends



Perfection in roll-forming technology

Flexibility and freedom of design

The unique formability of Kalzip aluminium profiled sheets enables design and functionality to be combined with technical perfection. The range of shapes available – convex, concave, elliptically or hyperbolically curved – opens up a whole variety of fascinating options for creating stunning architectural designs.

Perfection in production

The high-precision Kalzip components can be produced using the very latest equipment both in the factory and also on mobile roll formers to create a variety of complex shapes and geometric options. Numerous patents and utility models are clear evidence of the unique features and technological preeminence of this system. Even unconventional roof shapes are subject to no restriction. In addition to aluminium, it is also possible to process other materials such as stainless steel, copper and AluPlusZinc. The large number of mobile roll formers which are in operation throughout the world, guarantees an economical and sophisticated complete solution with minimum logistical costs and without having to compromise on creative architectural design. The unique advantages of on-site production are clearly evident when continuous sheet lengths in excess of 150 metres are used to cover large spans.



Above:
Project: Cite Shopping Mall, Germany
Architect: Form A Architects



Above:
Project: Basketball Sports Hall, Croatia
Architect: Marjan Hrčić, Zagreb



Project: Aintree racecourse, Liverpool, UK
 Architect: Building Design Partnership

Available shapes

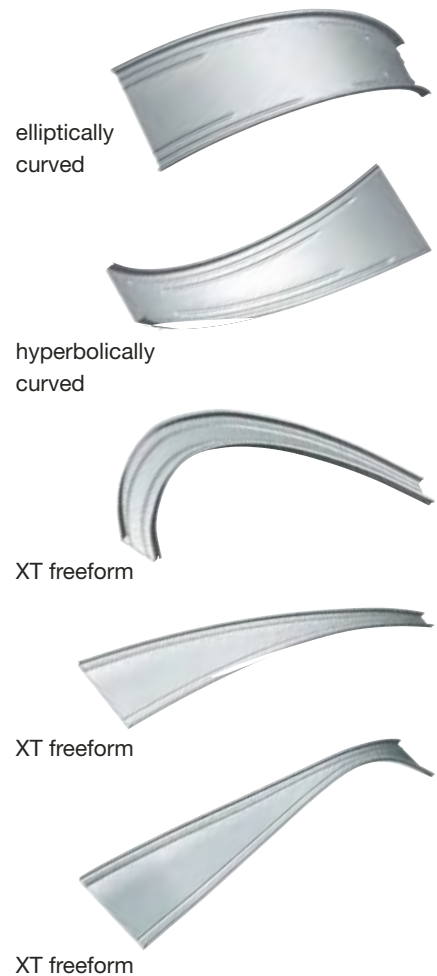

Kalzip XT Profiles

The advent of a new architectural era

Malleable, pliable, foldable and flexible, Kalzip XT profiled sheets make it possible to transform computer-generated designs and structural principles into reality. These evolutionary animations, visualized in 3D objects, enable new architectural shapes and forms to be created.

Revolutionary in its field this computer controlled patented roll forming technology allows three dimensional contouring to be combined with a standing seam system to achieve technical perfection in the creation of free flowing shapes. The ability to achieve extremely tight radii guarantees unusual shapes of buildings, including: ellipses, cones, semi-spheres, prisms, pyramids, as well as classic geometrical shapes – both horizontal and vertical.

Left top:

Project: Emmen Hospital, The Netherlands
 Architect: A/d Amstel Architects

Left bottom:

Project: Vigo University, Spain
 Architect: Xosé Carlos Rodríguez



Form and functionality

System configurations

Kalzip standing seam roof systems are available in a multitude of configurations to cater for the most challenging architectural design or most exacting performance requirements

Kalzip liner roof system

Kalzip liner roof systems are predominantly used for new build construction, although they can also be used for refurbishment in the event of other failed roofing systems or building enhancements.

The Kalzip liner roof system is ideal where speed of installation on a project is of utmost importance. A non-fragile walkable Kalzip liner sheet can be quickly installed to provide a weather cover to allow other trades to work below. The remainder of the roofing components can then be installed without affecting the critical path of the construction programme.

The Kalzip liner roof system has the outer Kalzip standing seam roof sheet and the internal Kalzip liner trapezoidal profiled liner sheet laid in the same direction across roof purlins acting as the primary support. Typical purlin centres would be approximately 1.4 to 1.8 metres.

The Kalzip standing seam roof sheets are supported directly off the roof purlins via the support clips/halters (aluminium clips or E clips) so therefore act

independently of the Kalzip liner sheet. When lightweight quilt type insulation is used, the external loads (wind suction, snow, access etc.) are transferred direct to the support purlins and not the liner sheet.

The profile and thickness of the Kalzip standing seam roof sheet will be determined by the external loads and the purlin centres.

The profile of the Kalzip liner sheets will be determined by its dimensional compatibility with the Kalzip standing seam roof sheet and its thickness will be determined by the internal wind pressure, the purlin centres, dead weight of the construction components, its walkability requirement and its non-fragility rating.

Materials and finishes

Kalzip liners are available as standard in high grade steel or aluminium. Standard finishes include a galvanised, or white enamel finish to suit the internal application.

A full range of alternative colours and coatings is also available on request.

For detailed information on load/span capability, U-values and acoustic variations of the Kalzip liner roof system please refer to pages 21 and 56 onwards or contact the Kalzip technical department.



Project: Colchester Garrison, UK
Architect: W S Atkins



Project: Cardiff International Pool, Wales, UK
Architect: S&P Architects

Below:
Project: University of East London
Knowledge Dock London, UK
Architect: BDP



Kalzip liner roof system variations

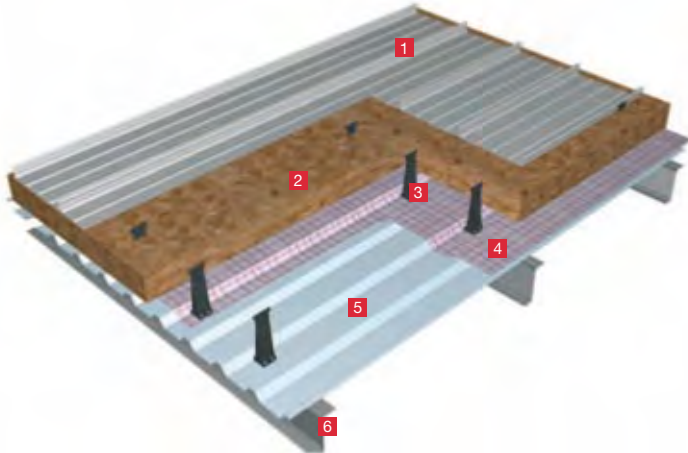

Standard liner roof configuration

- 1 Kalzip standing seam sheet
- 2 Kalzip insulation
- 3 Kalzip E clip
- 4 Kalzip vapour control layer
- 5 Trapeziodal liner sheet
- 6 Purlin

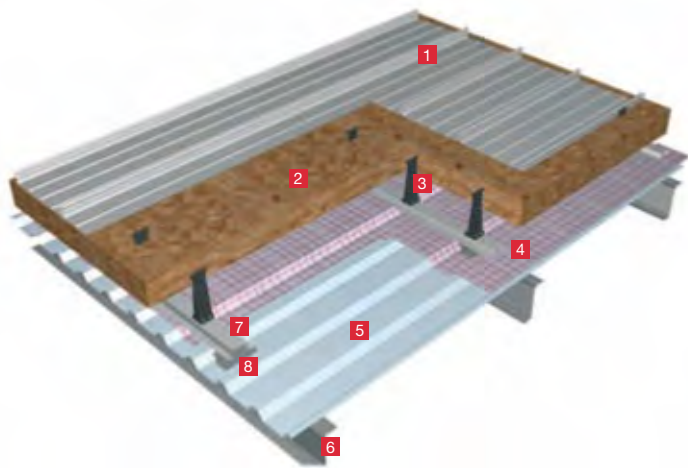

Liner with top hat spacer system for increased U-values

- 1 Kalzip standing seam sheet
- 2 Kalzip insulation
- 3 Kalzip E clip
- 4 Kalzip vapour control layer
- 5 Trapeziodal liner sheet
- 6 Purlin
- 7 Top hat sub purlin
- 8 Top hat saddle bracket

Liner profiles

TR 30/150
(Kalzip 65/300 profile)

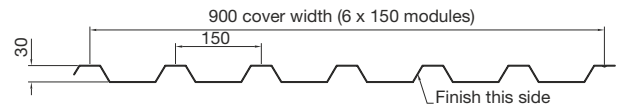

TR 30/152
(Kalzip 65/305 profile)

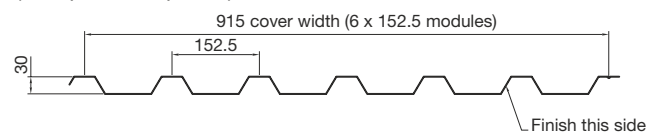

TR 30/167
(Kalzip 50/333 profile)
(Kalzip 65/333 profile)
(Kalzip 65/500 profile)

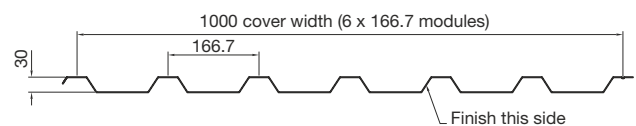

TR 35/200
(Kalzip 65/400 profile)

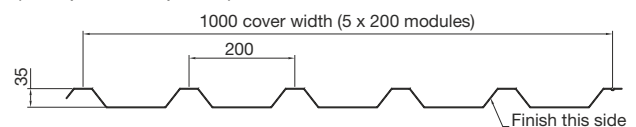

TR 35/215
(Kalzip 50/429 profile)

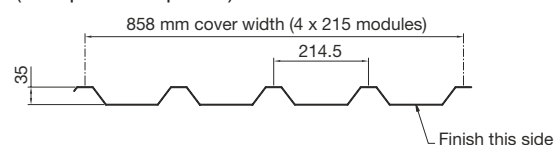

Kalzip structural deck system

Kalzip structural decking provides an economical solution for long span installations and eliminates the need for purlins. For enhanced acoustic absorption, decking sheets can be perforated and can support mass, such as increased insulation or board, which may be introduced for more rigorous acoustic specifications.

With a choice of steel or aluminium, a selection of profiles, gauges and sheet lengths – this range of products has been developed to extend the versatility of Kalzip, making it suitable for a wide range of applications.

As a general rule, steel is cost effective and provides the optimum in loading and spanning capability; whereas aluminium offers exceptional durability in buildings with high humidity levels such as swimming pools and wet industrial process plants, e.g. paper mills.

Where structural decking is installed there is a reduced requirement for secondary steelwork. The Kalzip structural decking sheet is generally laid transverse to the direction of the Kalzip standing seam roof sheet and spans between the main steel rafters.

Typical rafter centres would be approximately 3 to 8 metres.

The Kalzip clips are installed in a diagonal layout so that all external roof loads can be evenly distributed to the structural decking sheet. The frequency of clips may be increased at the perimeter of the building where higher wind loads occur.

The gauge and profile of the Kalzip structural decking sheet is therefore determined by the rafter centres, all external roof loads, internal wind loads, service loads (e.g. lighting) and the dead weight of the construction components.

The complete range of Kalzip 65, 50 and AF standing seam profiles are suitable for use with Kalzip structural decking.

Materials and finishes

Kalzip structural decks are available as standard in high grade steel and a selected range is also available in aluminium for specific applications.

Standard finishes for decking sheets are:

- Hot-dip galvanized, natural finish, ideal for situations where the deck is not visible or where visual appearance is not critical.

- White polyester coated on hot-dip galvanized substrate. This finish is highly durable, resists scratching and has good formability, suitable for exterior soffits.

A full range of alternative colours and coatings is also available on request.

Before any Kalzip deck sheet specification/order is determined, project specific calculations **MUST** be undertaken to assess which deck sheet is required. The calculation will also determine the fasteners required to meet the project loading.

Structural decking calculations are prepared by Kalzip's technical department.

Acoustics

Perforated decking will improve the acoustic conditions within a building by helping to optimise reverberation times. Furthermore, the decking sheets can contribute to noise reduction and noise containment within the building by the inclusion of mass above the decking sheet. To obtain the correct specification for precise requirements, please contact our technical department.



Project: Enerigus Centre of Excellence
Workington, UK
Architect: Plus (UK) Ltd



Project: Horsenden School, Middlesex, UK
Architect: Babcock SGI



Project: Sun Life Court, Bristol, UK
Architect: Atkins, Walters & Webster Architects

Kalzip structural deck roof system – variations

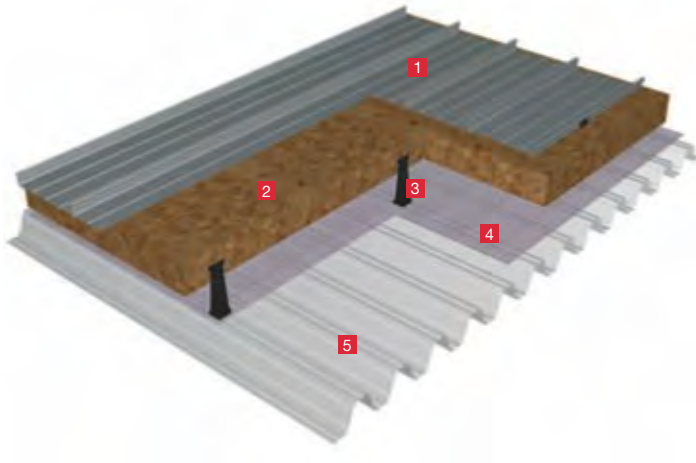

Kalzip standing seam on Kalzip structural decking

- 1 Kalzip standing seam sheet
- 2 Kalzip insulation
- 3 Kalzip E clip
- 4 Kalzip vapour control Layer
- 5 Structural decking

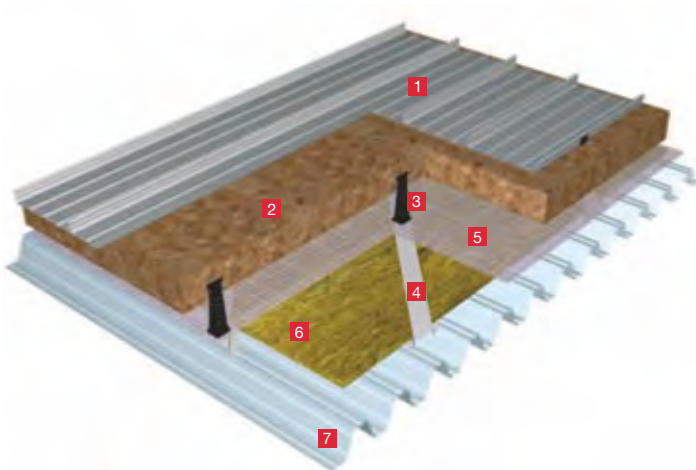

Kalzip standing seam on perforated Kalzip structural decking with acoustic insulation slab

- 1 Kalzip standing seam sheet
- 2 Kalzip insulation
- 3 Kalzip E clip
- 4 Low profile top hat section positioned diagonally across decking
- 5 Kalzip vapour control layer
- 6 Acoustic insulation slab
- 7 Perforated structural decking

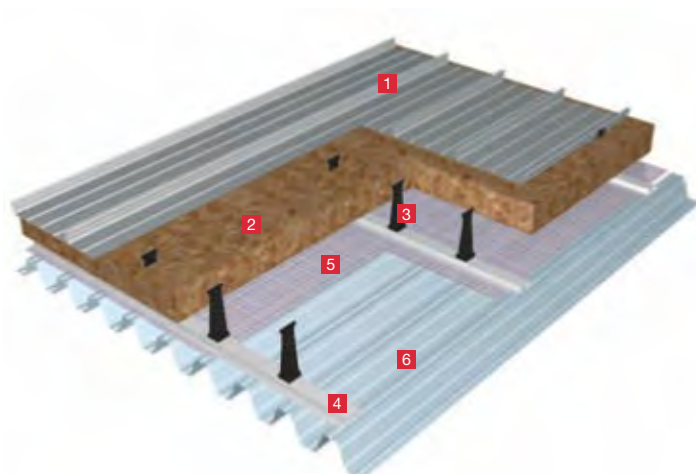

Kalzip standing seam on Kalzip structural decking with top hat sub purlins

- 1 Kalzip standing seam sheet
- 2 Kalzip insulation
- 3 Kalzip E clip
- 4 Top hat sub purlins riveted to decking
- 5 Kalzip vapour control layer
- 6 Structural decking

Structural decks

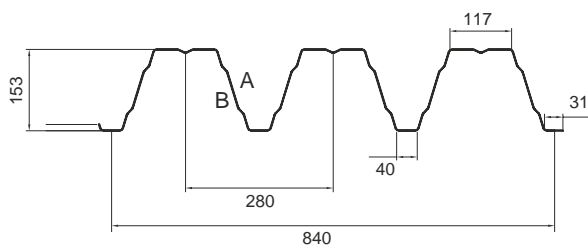
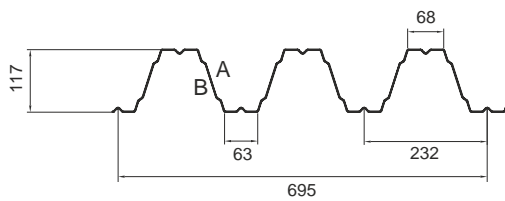
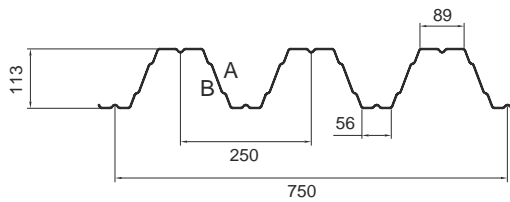
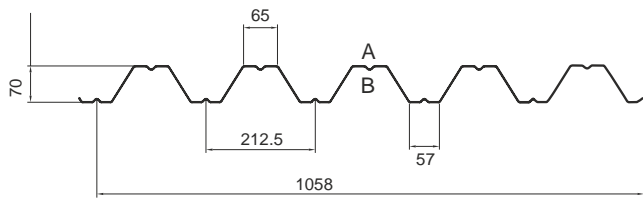
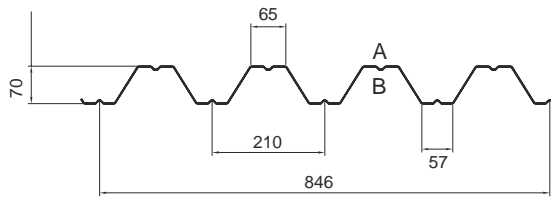
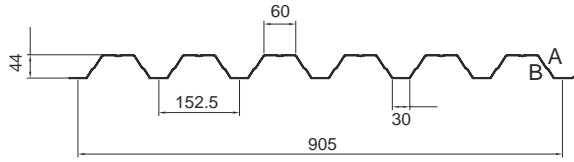

Note:

Information on aluminium decks is available from the Kalzip technical department

Structural deck dimensions for steel

45St profile

Thickness (mm)	Indicative weight (kg/lm)	(kg/m ²)
0.7	7.12	7.78
0.8	8.13	8.89
0.9	9.15	10.0
1.0	10.17	11.11

70St profile 846 (c/w)

Thickness (mm)	Indicative weight (kg/lm)	(kg/m ²)
0.7	6.9	8.1
0.8	7.9	9.3
0.9	8.8	10.4
1.0	9.9	11.6

70St profile 1058 (c/w)

Thickness (mm)	Indicative weight (kg/lm)	(kg/m ²)
0.7	8.13	7.68
0.88	10.20	9.64
1.0	11.59	10.95

113St profile

Thickness (mm)	Indicative weight (kg/lm)	(kg/m ²)
0.7	7.0	9.3
0.8	8.0	10.7
0.9	9.0	12.0
1.0	10.0	13.3
1.1	11.0	14.7
1.2	12.0	16.0

120St profile

Thickness (mm)	Indicative weight (kg/lm)	(kg/m ²)
0.7	6.9	9.9
0.8	7.9	11.3
0.9	8.9	12.7
1.0	9.8	14.2
1.1	10.8	15.6
1.2	11.8	17.0

153St profile

Thickness (mm)	Indicative weight (kg/lm)	(kg/m ²)
0.70	9.0	10.7
0.88	10.6	12.6
1.00	12.0	14.3
1.13	13.6	16.1
1.25	15.0	17.9
1.50	18.0	21.4

Weight in kg/m² also includes standard side overlap

Structural tray

Liner tray dimensions for steel

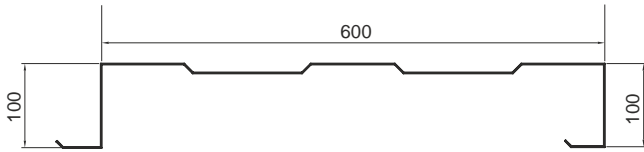

H = 100

Sheet thickness t (mm)	Design value of thickness t (mm)	Cross-sectional area A (cm ² /m)	Mass G (kg/m ²)
0.9	0.86	13.12	10.03
1.0	0.96	14.64	11.49
1.2	1.16	17.67	13.87
1.5	1.46	22.21	17.44
2.0	1.96	29.76	23.36
2.5	2.46	37.27	29.26

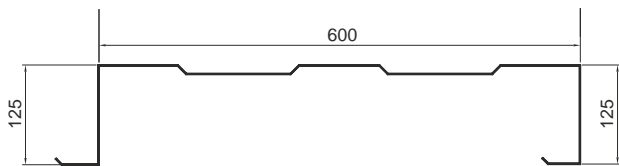

H = 125

Sheet thickness t (mm)	Design value of thickness t (mm)	Cross-sectional area A (cm ² /m)	Mass G (kg/m ²)
0.9	0.86	13.84	10.86
1.0	0.96	15.44	12.12
1.2	1.16	18.64	14.63
1.5	1.46	23.43	18.39
2.0	1.96	31.39	24.64
2.5	2.46	39.32	30.87

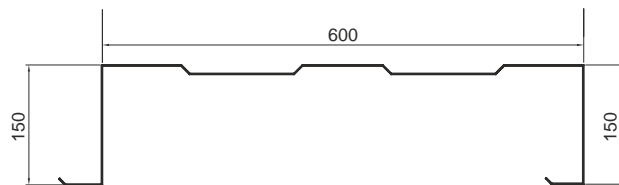

H = 150

Sheet thickness t (mm)	Design value of thickness t (mm)	Cross-sectional area A (cm ² /m)	Mass G (kg/m ²)
0.9	0.86	14.85	11.42
1.0	0.96	16.24	12.75
1.2	1.16	19.61	15.39
1.5	1.46	24.65	19.35
2.0	1.96	33.03	25.93
2.5	2.46	41.37	32.48

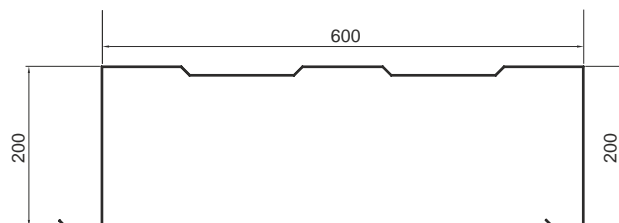

H = 200

Sheet thickness t (mm)	Design value of thickness t (mm)	Cross-sectional area A (cm ² /m)	Mass G (kg/m ²)
0.9	0.86	15.99	12.55
1.0	0.96	17.84	14.00
1.2	1.16	21.54	16.91
1.5	1.46	27.08	21.26
2.0	1.96	36.29	28.49
2.5	2.46	45.47	35.70

Note:

Information on aluminium structural trays is available from the Kalzip technical department. The above diagrams are based on nominal measurements. Red text = indicate folded profile ie: sheet thickness: 0.9mm-1.5mm is roll formed, 2.00mm, 2.5mm is folded. Where required, for exceptionally long spans, the spanability of both decking and trays can be extended by the introduction of special sections within the profiles.

Liner deck

Kalzip liner deck (KLD) 32

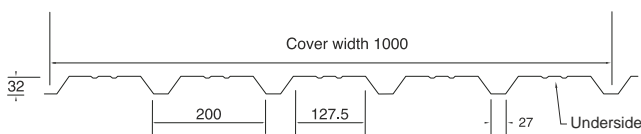

Kalzip liner deck (KLD) 35

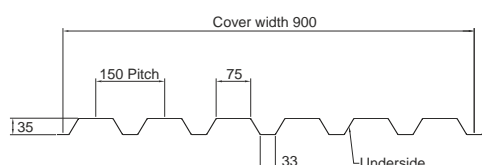

Kalzip liner deck (KLD) 46

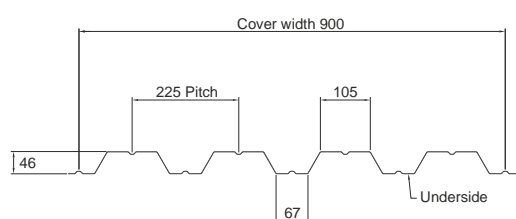

Kalzip liner-deck roof system

A variation of the Kalzip liner roof system, the Kalzip liner-deck roof system utilises a low profile structural metal deck.

This roof construction consists of a Kalzip standing seam outer sheet, Kalzip insulation, Kalzip vapour control layer and a Kalzip liner-deck sheet. The Kalzip standing seam outer sheet is supported off Kalzip aluminium or E clips in turn supported off a top-hat profile sub-purlin fixed direct to the Kalzip liner-deck sheet.

Kalzip liner-deck roof systems are predominantly used for new build construction where purlin centres are greater than normal, where high density insulation is required (e.g. where wide tapered Kalzip roof sheets or fully supported Kalzip AF sheets are used) or where low U values are required.

The Kalzip liner-deck roof system is ideal where speed of installation on a project is of utmost importance. A non-fragile walkable Kalzip liner-deck sheet can be quickly installed to provide a weather cover to allow other trades to work below. The remainder of the roofing components can then be installed without affecting the critical path of the construction programme.

The Kalzip liner-deck roof system has the outer Kalzip standing seam roof sheet and the internal Kalzip liner-deck trapezoidal structural decking sheet laid in the same direction across roof purlins acting as the primary support. The main difference between this construction and the more common Kalzip liner roof system construction is that the Kalzip standing seam outer sheet is supported direct off the Kalzip liner-deck via clips and top-hat sub-purlins.

The top-hat sub-purlins may be fixed direct over the purlins only (if the purlin centres are suitable for the Kalzip standing seam sheet) or for wide purlin spacings further top-hats can be installed mid-span.

This arrangement transfers the external roof loads as line loads to the Kalzip liner-deck when lightweight quilt-type insulation is used.

When high-density insulation is used within the roof system the external downward loads (e.g. snow) would be transferred as uniformly distributed loads.

The thickness and profile of the Kalzip liner-deck is therefore determined by the

purlin centres, all external roof loads, internal wind loads, the dead weight of the construction components, its walkability requirement and its non-fragility rating.

The external roof loads will determine the Kalzip standing seam support set out centres.

The complete range of Kalzip 65, 50 and AF standing seam profiles are suitable for use with Kalzip liner-deck.

Materials and finishes

Kalzip structural decks are available as standard in high grade steel or aluminium. Standard finishes include a galvanised finish or white polyester coated for a more aesthetically pleasing appearance.

A full range of alternative colours and coatings is also available on request.

For detailed information on load/span capability, U-values and acoustic variations of the Kalzip liner-deck roof system please refer to page 21 and 56 onwards in this brochure or contact the Kalzip technical department.



Project: Millennium Grandstand, Newmarket, UK
Architect: The Goddard Wybor Practice



Project: Howells Junior School, Cardiff, UK
Architect: Girl's Day School Trust

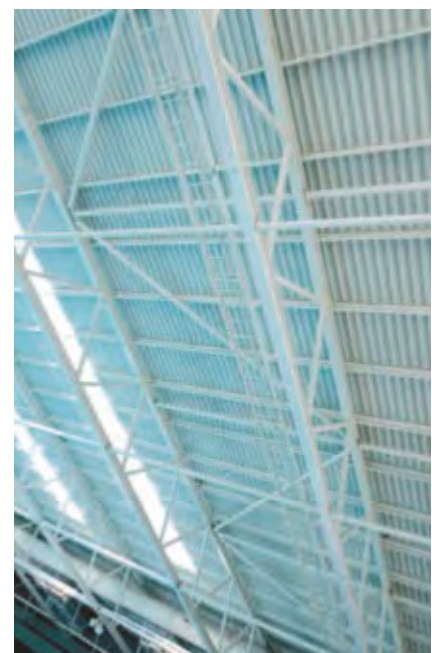

Project: Cardiff International Pool, Wales, UK
Architect: S&P Architects

Kalzip liner-deck roof system – variations

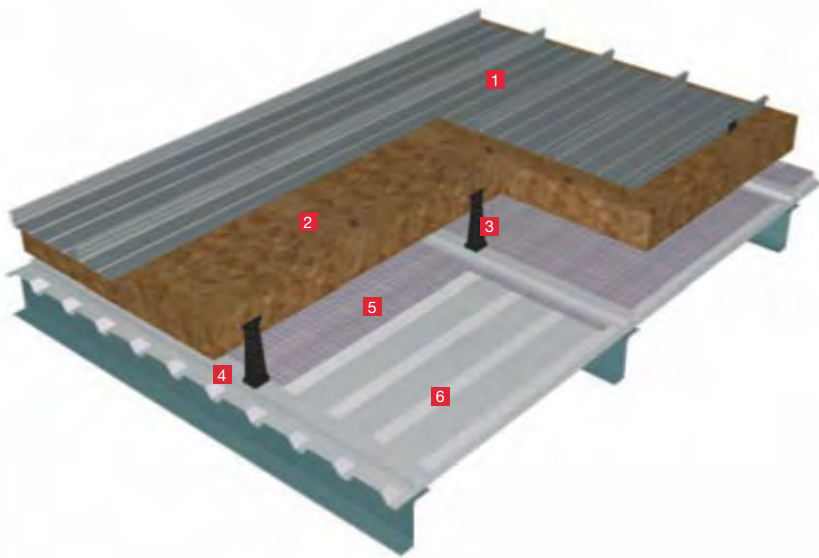

Standard liner deck system configuration

- 1 Kalzip standing seam sheet
- 2 Kalzip insulation
- 3 Kalzip E clip
- 4 Top hat sub purlins
- 5 Kalzip vapour control layer
- 6 Liner-deck profile steel or aluminium

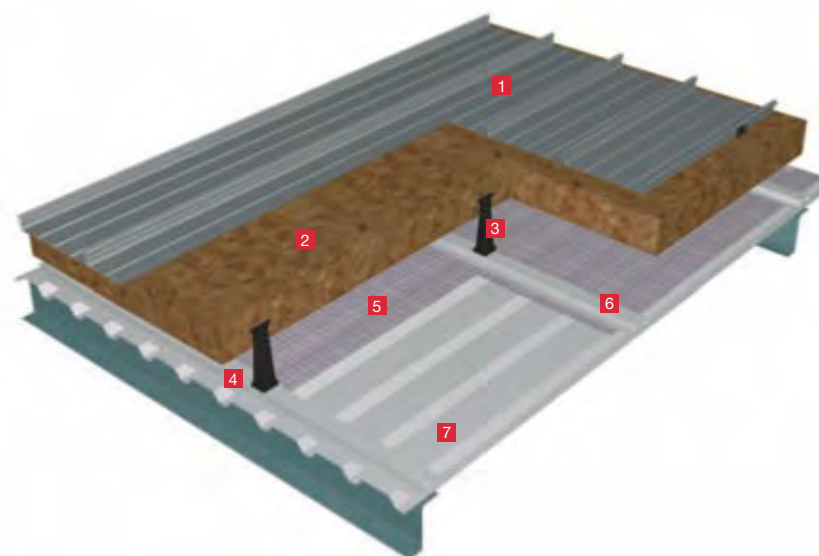

Standard liner deck system configuration with intermediate top hat sub purlin

- 1 Kalzip standing seam sheet
- 2 Kalzip insulation
- 3 Kalzip E clip
- 4 Top hat sub purlins
- 5 Kalzip vapour control layer
- 6 Mid-span top hat sub purlins fixed directly to deck
- 7 Liner-deck profile steel or aluminium

Kalzip low U-value system

Kalzip's low U-value roof system provides a cost effective and technically sound solution for roof U-values as low as 0.10 W/m²/K by combining rigid insulation boards with glass mineral fibre layers.

It is the symbiosis of the two insulation types that gives the system its high performance and uniqueness in

achieving extremely low U-values, allowing a significantly greater overall thermal resistance to be achieved compared to that of any one single layer of insulation of the same total thickness.

The low U-value system is primarily based on a standard Kalzip standing seam roof build and as such is

subject to the same basic set of criteria and properties for materials, finishes, geometries, accessories and components as outlined in the Kalzip systems brochure.

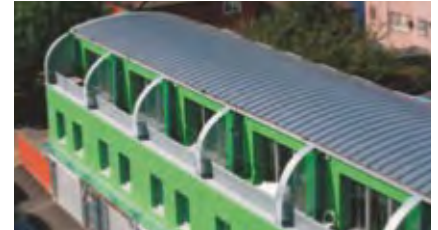

Project: CO₂Zero Live/Work Scheme, Bristol, UK
Architect: Brandon Lloyd

System configurations

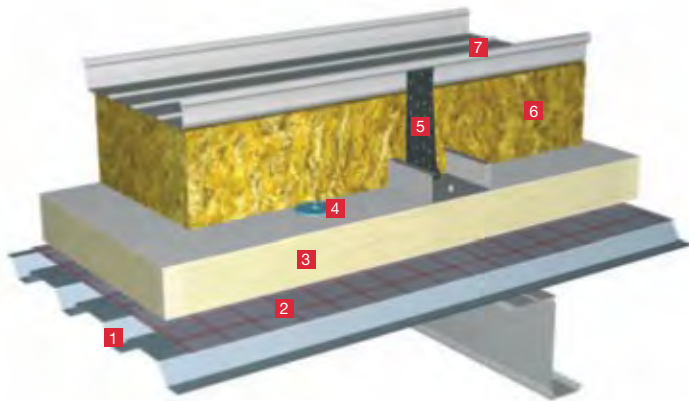

- 1 Inverted liner sheet over purlins
- 2 Kalzip vapour control layer
- 3 Kalzip insulation 23 (2400 mm x 1200 mm)
- 4 SFS Iso-Tak fastener system
- 5 Kalzip E clips fixed to inverted channel
- 6 Mineral fibre quilt insulation
- 7 Kalzip top sheet

Liner roof system

The Kalzip low U-value liner roof system consists of a conventional trapezoidal steel liner sheet laid with the wide flange side facing upward.

The wide flange up provides a greater bearing surface to support the inner layer of Kalzip insulation 23.

This is a fire retardant polyisocyanurate (PIR) rigid foam board available in a range of thicknesses.

A second layer quilt of mineral fibre insulation is laid on top of this creating a hybrid or "duo" system shown above.

Using this combination of rigid board and mineral fibre insulation materials allows a significantly greater overall thermal resistance to be achieved compared to that of a single layer of mineral fibre of the same thickness.

Liner-deck spanning between purlins

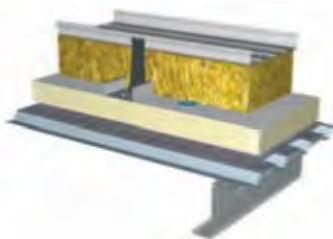

Liner-deck roof system

The liner-deck system is a variation of the standard liner system. A higher structural grade of steel is used to allow the clip rails to be positioned away from purlins.

Structural metal deck spanning between rafters

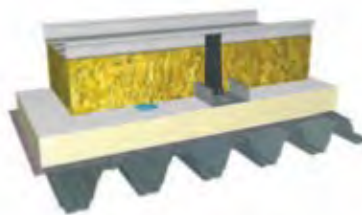

Structural deck roof system

The liner-deck system is a variation of the standard liner system. A higher structural grade of steel is used to allow the clip rails to be positioned away from purlins.

Timber decking

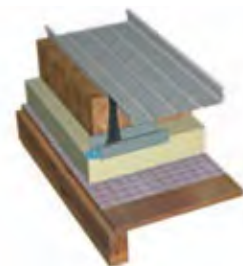

Timber deck roof system

Timber (or SIPS) decking provides a popular sustainable solution for supporting roof constructions. Please contact our technical services department for fastener pull out values.

Kalzip standing seam

System variations

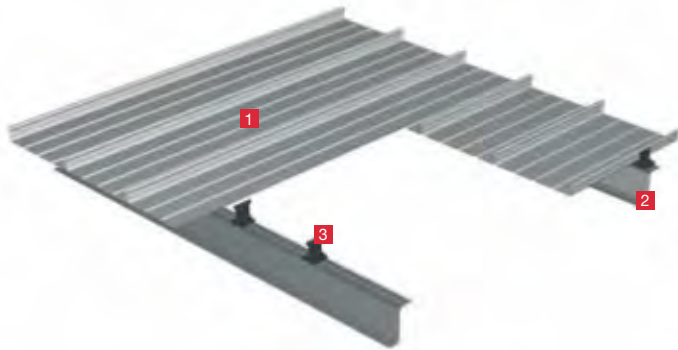

Kalzip single skin roof

- 1 Kalzip standing seam sheet
- 2 Purlins [by others]
- 3 Extruded aluminium or reinforced polyamide E clips



Kalzip cold roof over timber

- 1 Kalzip standing seam sheet
- 2 Vapour permeable underlay
- 3 Extruded aluminium or reinforced polyamide E clips
- 4 Timber substrate
- 5 Rafter/trusses
- 6 Kalzip insulation
- 7 Kalzip vapour control layer

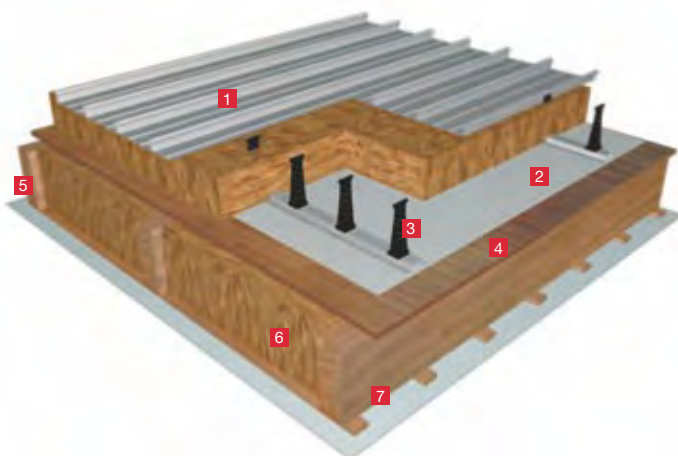

Kalzip warm roof over timber

- 1 Kalzip standing seam sheet
- 2 Vapour permeable underlay
- 3 Extruded aluminium or reinforced polyamide E clips/top hats
- 4 Timber substrate
- 5 Rafter/trusses
- 6 Kalzip insulation
- 7 Kalzip vapour control layer

Kalzip acoustic systems Solutions for auditory applications

Project: Manchester Aquatics Centre, UK
Architect: FaulknerBrown Architects

Tailored to high acoustic performance

Combining Kalzip's proven durability and versatility with effective acoustic insulation

Kalzip roof constructions can be modified to accommodate various acoustic performance requirements, by incorporating other layers such as high density insulation, acoustic boards and flexible membranes to provide increased sound reduction performance and by perforating the liner to provide improved sound absorption performance.

With Approved Document E the acoustic performance is an important consideration in the design of buildings, especially within the education sector. Multi-layer forms of construction achieve better results and the built-up Kalzip system allows for many combinations to address various acoustic requirements within a building. By using its different system variations Kalzip can assist in achieving the right sound reduction and/or absorption levels required for specific applications.

Over 120 tests have been conducted worldwide on Kalzip roof constructions for airborne sound reduction and sound absorption levels.

Sound absorption

Sound absorption is achieved by perforating the metal liner sheet and incorporating a 'soft' absorbing material behind it. Different combinations of perforations and levels of insulation will give varying results of sound absorption.

Air-bourne sound reduction

A standard insulated Kalzip roof construction will have an approximate weighted sound reduction (Rw) of 33dB with an aluminium trapezoidal liner and 36dB with a steel trapezoidal liner.

The Rw can be increased by varying the number and the densities of the insulation layers as well as adding additional mass into the construction e.g. through the incorporation of high density Kalzip insulation, Kalzip acoustic board or Kalzip acoustic membrane, etc.

Recent tests carried out incorporating varying types and levels of mass have recorded sound reduction rates of between 33dB and 52dB depending on the product combinations applied.

A valid consideration is Kalzip Nature Roof which adds weight and therefore 'mass' to a Kalzip system build up – 90 kg/m² when fully saturated. This solution can be a natural way of providing improved acoustic performance whilst enhancing the building aesthetics.

Impact noise

It is a requirement of BB93 that the control of rain noise on roofs should be considered either by external damping treatment or by enhancing the mass of the panels. The latter requires either internal mass barriers or underlining the roof panels with plasterboard or a heavy lay in grid system. BB93 prefers that laboratory test data be used to demonstrate the performance of the roof.

Flanking

For further information on flanking contact the Kalzip technical department.



Project: Dublin Airport, Ireland
Architect: Pascall+Watson



Project: Stafford Leisure Centre, UK
Architect: Barnett Ratcliffe



Project: Campbell College Junior School
Architect: Hobart & Heron

Kalzip Nature Roof

A robust and sustainable green roof system

Below left:

Project: PFI Defence 6th Form College, Loughborough, UK
Architect: HLM Design Limited

Below middle left:

Project: House of the Future, Cardiff, UK
Architect: Jestico and Whiles

Below middle right:

Project: Pizza Hut, Jersey, UK
Architect: Carlo Riva Architects/MEPK Architects

Below right:

Project: Grove Health & Wellbeing Centre, Ireland
Architect: Kennedy Fitzgerald & Associates

Bottom:

Project: Lough Road Waste Treatment Works, London, UK
Architect: Sheppard Robson Architects



The Kalzip Nature Roof is unique both in terms of its construction and design

The Kalzip Nature Roof is an advanced green roofing system that has been developed to provide measurable performance and environmental benefits. A perfectly balanced and complete solution – it not only meets high environmental, technical and design requirements, but also enhances the aesthetic appeal of a building.

The Nature Roof is underpinned by a fully engineered Kalzip system with an unbeatable pedigree. Every single component has been carefully selected for compatibility; the system as a whole has been subjected to the most rigorous testing for the UK.

This lightweight roofing system improves thermal performance and is kind on resources – essential features for intelligent and environmentally friendly architecture. By providing protection against heat loss in the winter and

heat gain in the summer, the internal environment is enhanced by more constant temperatures.

Extensive greening with low-maintenance the Nature Roof provides almost total plant cover – low-growing, self-regenerating, drought-resistant sedum plants transform dreary roofscapes into an oasis of colour which changes with the seasons.

The release of oxygen by the plants, brings measurable improvements to the surrounding micro-climate whilst at the same time the plant leaves take in and ‘lock-up’ air borne pollutants such as particulates from traffic fumes and dust.

Nature Roof can lead to dramatic improvements in air quality around the building and where large-scale roof greening occurs, to the air quality of entire conurbations.

Benefits at a glance

- The NatureRoof is constructed directly onto the Kalzip profile panels without the need for additional sealing work.
- The aluminium surface offers lasting protection against rooting and moisture penetration.
- Nature Roof offers the same level of planning security, ease of handling and recognised performance characteristics that you would expect from the Kalzip building system.
- The roof still acts as a lightning conductor.
- All components are environmentally friendly and can be recycled.
- Uniform planning – even if only sections of a roof are to be landscaped.

Below:

Project: West Ham Bus Depot, London, UK
Architect: Pringle Richards Sharrat Architects

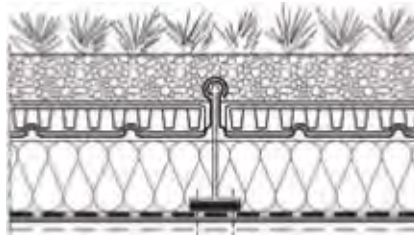

The additional features of the Kalzip Nature Roof are certainly impressive:

- Significant reduction in the load placed on the drainage system and time delayed release of excess rainwater into the local and domestic drainage systems.
- Reduced load placed on the drainage culverts, storage tanks, sewage plants and rivers.
- Considerable reduction in waste water and sewage costs.
- Approximately 50% of the rainwater is stored.
- Approximately 30% of the rainwater retained by Kalzip NatureRoof® is returned to the natural cycle by evaporation.
- Improved oxygen levels, improved microclimate and air humidity in the area surrounding the building.
- Absorption of dust and pollution such as CO₂.
- Thermal and mechanical protection against the effects of temperature, weather and radiation.
- Improvement of sound insulation, internal and external noise is reduced.
- Improved thermal insulation and room climate throughout the year.
- Temperature peaks are levelled out and variations caused by temperature fluctuations are reduced.
- Creates a more attractive and comfortable place in which to live and work.
- Increases the value of the building.
- Provides an ecological balance in the face of increasing urbanisation.

For further details visit www.kalzip.com or contact us on 01942 295500

Kalzip solar solutions

AluPlusSolar and SolarClad

Project: Levenshulme High School,
Manchester, UK
Architect: Walker Simpson Architects



Sustainable architectural aesthetics

A roof-integrated source of renewable energy

The durability of Kalzip profiled sheets and the efficiency of solar modules now make it possible to create contemporary, modern buildings which combine maximum freedom of architectural design with the integration of ecological concepts.

Kalzip AluPlusSolar is a fully integrated photovoltaic envelope product. Photovoltaic laminates, available in two lengths, are factory-bonded directly to the outer surface of the exterior Kalzip sheets. The photovoltaic laminates consists of triple-junction thin-film silicon cells deposited onto a stainless steel foil and encapsulated in an ethane vinyl acetate (EVA) co-polymer protective envelope. Each of the three cells converts a different part of the visible

spectrum, resulting in superior conversion efficiencies even in overcast conditions.

The photovoltaic laminates are bonded to polyvinylidene difluoride (PVdF) or polyester paint-coated all flat AF65/537 aluminium profiles. No penetrative fixings are required.

Designs include straight, convex or concave barrel vault or mono-pitch roofs, as well as individual Kalzip standing seam roof designs.

Kalzip AluPlusSolar	AF 65/537 mm
Sheet thickness	1.0 mm
Weight	Approx. 7.0 kg/m (incl. solar laminates)

Benefits at a glance

- Attractive, roof-integrated photovoltaics without additional fixing elements
- Optimum utilization of solar energy even in weaker light conditions through triple-junction technology
- Greater shade tolerance than crystalline modules through narrow-meshed bypass circuit
- Low-maintenance
- Suitable for use on insulated or non-insulated roofs
- Available as a complete system inclusive of inverter and accessories



Project: Schiller School, Bretten, Germany
Refurbishment project



Project: Schiller School, Bretten, Germany
Refurbishment project



Project: Shrewsbury High School, Shropshire, UK
Architect: The Girls Day School Trust



Project: Boatemah Walk, London, UK
Architect: Anne Thorne Architect Partnership

Product advantages

Triple-junction technology

The solar cells used in amorphous silicon thin-film laminates consist of three silicon layers applied one after the other. The different layers are optimized so that each layer can optimally convert a different range of the light spectrum to electrical energy. This enables greater efficiency in the diffuse light conditions of daylight in central and northern Europe.

State-of-the-art, amorphous thin-film modules allow electricity to be generated from solar energy in a highly efficient and regenerative manner. Modern thin-film technology offers the following benefits:

- Generates up to 20 % more energy than conventional crystalline modules as a result of Triple-Junction-Technology
- Greater shade tolerance through narrow-meshed bypass circuit
- Extremely light-weight – between 4 kg/m²-8 kg/m² incl. fixing elements

- For maximum power density and optimum energy generation, SolarClad can be installed as a stand-off mounting at a range of orientations and pitch.
- Extremely economical; non-penetrative, quick installation
- Environmentally-friendly due to short energy amortisation period < 3 years
- Improved thermal protection; shades roof in summertime
- The system is extremely lightweight and does not add significant additional demands on the roof

Areas of Use

Where designs combine the roof and facade via a curved or continuous eaves detail, advice should be obtained from your local office.

Kalzip AluPlusSolar is available with a choice of two different photovoltaic thin-film

solar modules PVL-68 and PVL-136, each with different performance characteristics.

- Suitable for all roof shapes with a pitch up to a maximum of 60° from horizontal.
- Can be retrofitted to existing Kalzip roofs
- Suitable for all standing seam materials, e.g. zinc and copper
- Attractively priced PV solution for new builds with Kalzip standard constructional widths
- Ideal for all roof shapes, in the case of barrel-vaulted roofs, follows contours up to 13 metre radius; convex or concave
- Normally no additional static demands on the substructure

A dedicated Solar Solutions brochure is available on the Kalzip website, www.kalzip.com

Versatile photovoltaic solutions

Flexibility in sustainable development

Kalzip SolarClad is a photovoltaic cladding which has been optimised for use in building envelopes. It can be retrofitted to existing installations or used in new builds.

The system consists of extremely robust thin-film modules made from amorphous silicon (a-Si), bonded onto aluminium carrier plates, which are installed onto the standing seam roof system in a non penetrative manner.

These extremely lightweight module units are suitable for all roof shapes and guarantee maximum freedom of design for planners and architects.

Product advantages

- Attractive, roof-integrated photovoltaics without additional fixing elements
- Optimum utilization of solar energy even in weaker light conditions through triple-junction technology
- Greater shade tolerance than crystalline modules through narrow-meshed bypass circuit
- Self-cleaning surface – therefore low-maintenance
- Suitable for use on insulated and non-insulated roofs
- Available as a complete system inclusive of inverter and accessories

Planning guidance

- In addition to SolarClad, the Kalzip AluPlusSolar roof integrated photovoltaic system is also suitable for new Kalzip roofs
- Recommended roof pitch min. of 3° (5%)
- Kalzip profiled sheets cannot be laminated once installed with thin-film solar modules, for retrofitting we recommend the use of Kalzip SolarClad
- Minimum radius in the area of the profiled sheets fitted with modules > 13 metres; convex or concave

Possible methods of installation

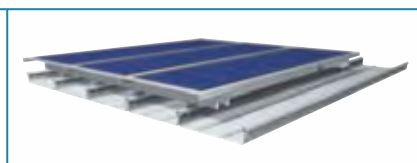

Kalzip SolarClad parallel to standing seams

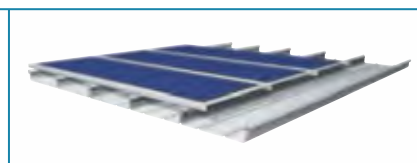

Kalzip SolarClad perpendicular to standing seams

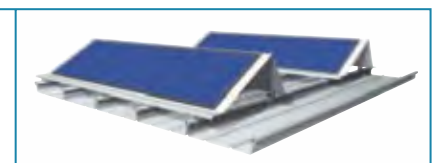

Kalzip SolarClad elevated from roof

Project: Energun Centre of Excellence, Workington, UK
Architect: Plus (UK) Ltd



Project: Walsall City Academy, Birmingham, UK
Architect: Barnsley Hewett and Mallinson Architects



Components & accessories

Kalzip's perfectly matched system components and comprehensive range of accessories provide the ideal complement to Kalzip's unlimited design potential.

Single skin and insulated gutters, ridge and verge details, soffits, bullnose fascias and flashings are amongst the range of products available to achieve consistency of material appearance and performance right across the roof. Developed strictly within the MCRMA guidelines, all Kalzip fabrications' accessories and manufacturing processes meet the relevant Health & Safety requirements.

With ever-tightening regulations, the technical performance of the installation details and interfaces is of paramount importance. Using the highest-grade alloy, with full traceability, Kalzip fabrications offer comprehensive support and, critically, supply minimum risk solutions to all essential roofing and cladding details.

A full range of safety products, including fall arrest systems and walkways is also available with installation being undertaken by a dedicated network of Height Safety specialists to ensure outstanding quality, performance and reliability right through to the very last detail and comply with the current building regulations and relevant industry standards relating to the required thermal insulation and fire protection of building envelopes. All Kalzip products have been tested to ensure they do not perforate the surface of the Kalzip sheet through the use of non-penetrative clamps fastened to the seams.



Clips

Kalzip profiled sheets are secured to the substructure of the roof construction by the use of extruded Kalzip aluminium clips (with associated polyamide thermal barrier pads) or the range of Kalzip E clips – steel reinforced polyamide clips designed to further enhance the performance of the overall Kalzip system by improving its thermal, acoustic and movement performance.

The clip heads are designed to freely accommodate movement of the external sheet during thermal cycling, enabling the use of very long sheet lengths.

National and International Building Regulations and standards are requiring that the full thermal bridging effect of a building fabric element be taken into account when determining its U-value.

By applying improvement factors and renewable energy benchmark targets to a 2002 compliant notional building the 2006 Building Regulations (ADL2A) set a target carbon dioxide emissions rate (TER).

The use of the patented E clips can help to lower U-values by almost eliminating any thermal bridging through the roof build-up.

As aluminium has a high conductivity of heat, a series of tests were carried out to determine the true thermal bridging effect of the Kalzip aluminium clips and the effectiveness of various thermal barrier pads.

The results lead to the introduction of a more efficient 15 mm deep thermal barrier pad (TK15) and the development

of the reinforced polyamide clips (Kalzip newly patented E clips), which offer a fixing mechanism with no significant thermal bridging whilst still retaining structural capability similar to the extruded aluminium clip.

In addition to ensuring minimal thermal impairment - the clips also reduce the frictional forces generated during thermal cycling of the external sheet.

The benefit of reduced friction enables us to recommend that the E clip be used on roof areas with effective sheet lengths exceeding 40 metres. The thermal performance of the Kalzip E clips has been derived from hot-box testing carried out to EN ISO 8990:1996 - Thermal Insulation - Determination of steady-state thermal transmission properties - Calibrated hot box.



Aluminium clip with thermal barrier pad

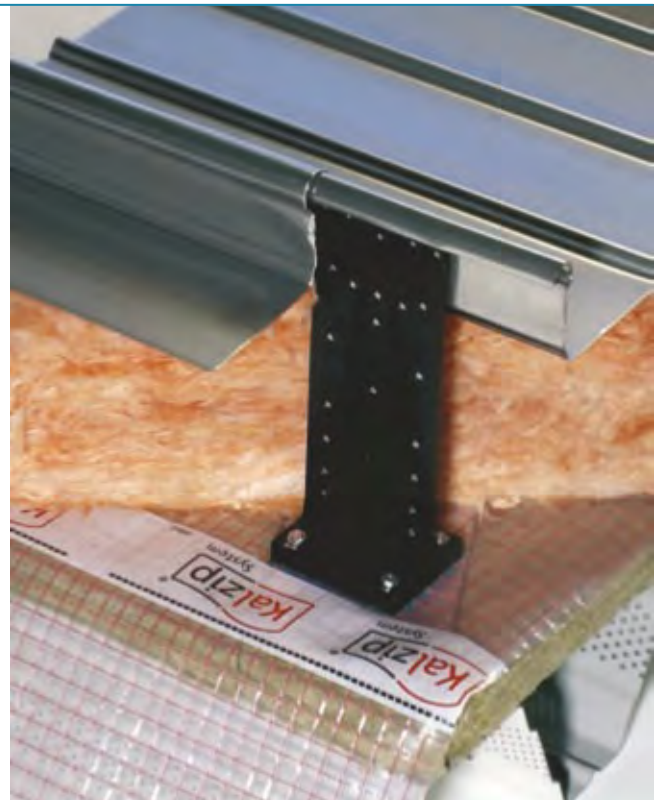

Polyamide E Clip



Kalzip E clip

The Kalzip advanced E clip is a steel reinforced GFRP clip that is available in 20 mm height increments, up to a maximum of 180 mm (see table 1).

Component mass and height

The table gives the mass and height of different E clip combinations. The overall clip height, H includes the height of the spacer pad where used. The cavity depth, W created with different Kalzip standing seams is also given.

Table 1

Clip type	Combination	Mass (g)	Overall Clip Height (H)	W (mm)		
				65/*	50/*	AF65/*
E-5	-	118	66	N/A	20	5
E-20	-	130	81	20	35	20
	E-20 + Spacer 10	157	91	30	45	30
E-40	-	146	101	40	55	40
	E40 + Spacer 10	173	111	50	65	50
E-60	-	166	121	60	75	60
	E60 + Spacer 10	193	131	70	85	70
E-80	-	178	141	80	95	80
	E80 + Spacer 10	205	151	90	105	90
E-100	-	194	161	100	115	100
	E-100 + Spacer 10	221	171	110	125	110
E-120	-	213	181	120	135	120
	E-120 + Spacer 10	240	191	130	145	130
E-140	-	228	201	140	155	140
	E-140 + Spacer 10	255	211	150	165	150
E-160	-	246	221	160	175	160
	E-160 + Spacer 10	273	231	170	185	170
E-180	-	263	241	180	195	180
Spacer 5	-	17				
Spacer 10	-	27				

Note: The values quoted for W do not take account of any reduction in the cavity as a result of fixing in the troughs of trapezoidal liner sheets.

Spacer Pads

In addition, there are two thicknesses of spacer pads available which can be added either individually to the base of the clip giving height increments of 5 mm and 10 mm respectively, or combined to give an overall maximum 15 mm increment.

The spacer pads are not supplied pre-fitted, they are site-applied only. The spacer pads can be used to provide tolerance for minor discrepancies in the underlying sub-structure.

Note: When using two spacers, the 10 mm pad must be fitted to the clip before the 5 mm and a maximum of **two spacer pads** only is permitted to increase the height of the clips.

Overall height (H) and cavity depth (W)

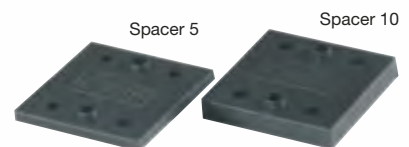
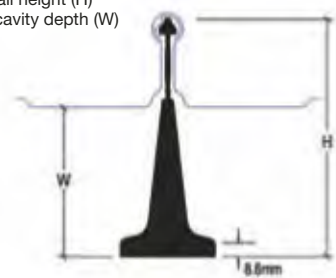

E clip base details

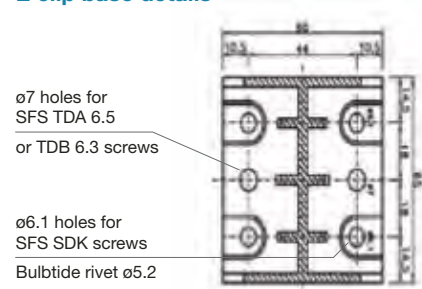

Clip dimensions and base details

L clip dimensions

Kalzip self-supporting sheet		Kalzip 65			Kalzip 50		
Clip type	Clip height H	w1	w2 (TK5)	w2 (TK15)	w1	w2 (TK5)	w2 (TK15)
L10	66	N/A	N/A	N/A	20	25	35
L25	81	20	25	35	30	40	50
L50	106	45	50	60	60	65	75
L60	116	55	60	70	70	75	85
L80	136	75	80	90	90	95	105
L90	146	85	90	100	100	105	115
L100	156	95	100	110	110	115	125
L110	166	105	110	120	120	125	135
L120	176	115	120	130	130	135	145
L130	186	125	130	140	140	145	155
L140	196	135	140	150	150	155	165
L150	206	145	150	160	160	165	175
L190	246	185	190	200	200	205	215

Clips shown in bold are the most popular for system solution.

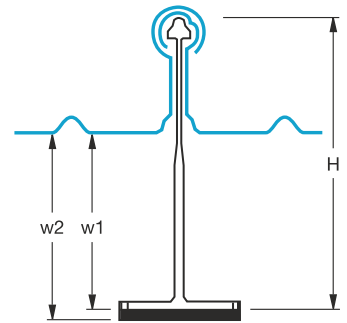

H = height of clip without thermal barrier pad

w1 = distance between underside of Kalzip sheet and underside of the aluminium clip

w2 = distance between underside of Kalzip sheet and underside of the aluminium clip with thermal barrier pad

Aluminium clip base details

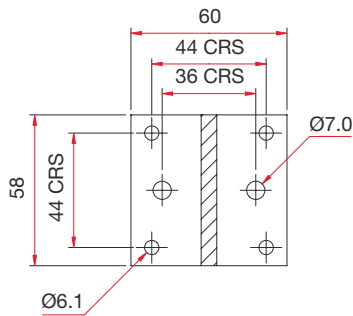

Standard clip base detail

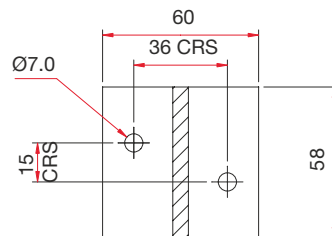

T clip base detail for fixing to minimum of 75 mm wide timber purlins for the above clips

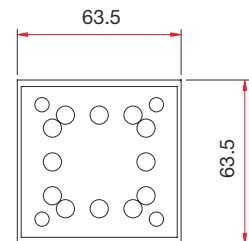

Thermal barrier pad

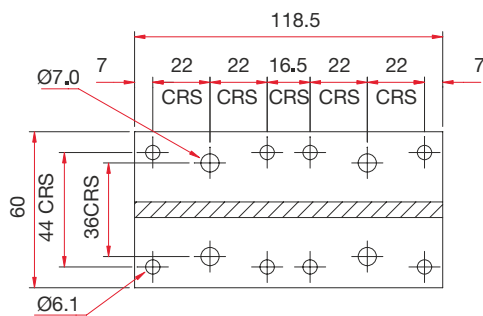

Double length clip base detail

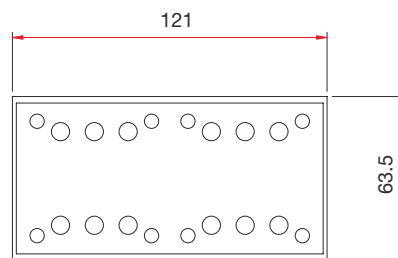

Thermal barrier pad for double length clip

Clip set out

Setting out tolerances

Kalzip is manufactured to high engineering tolerances because of the critical nature of the side lap arrangement and engagement over the head of the clip.

The tolerances outlined are recommended to enable Kalzip elements to accommodate full thermal movement over the clips without locking and introducing unwanted “fixed points”. It is assumed that the Kalzip element when fixed in place will follow a straight line or single curve over their entire length. Multiple curves resulting in dips or sudden changes in slope may cause a transfer of “fixed point”, thus making redundant the normal designed “fixed point”. For help and advice consult the Kalzip technical department

Variations in one line of clips

Clips must be vertical on the line of the roof pitch. Structural steelwork must allow for the installation of the clips within the stated tolerances.

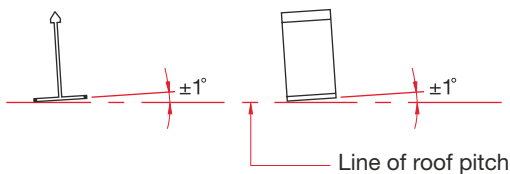

Clips must not be set-out skewed.

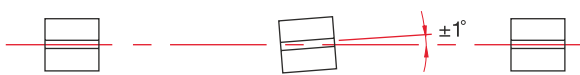

Vertical variation of clips heads in line (over any 3 purlins). Structural support must not vary in level between purlins.

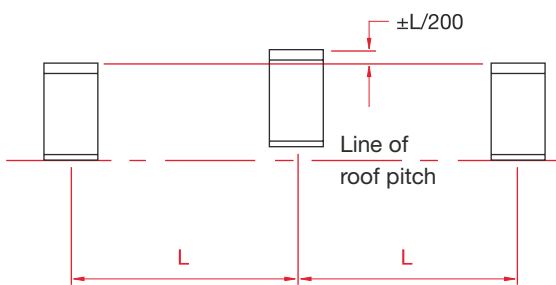

Plan variations of clip heads in line (over any 3 purlins).

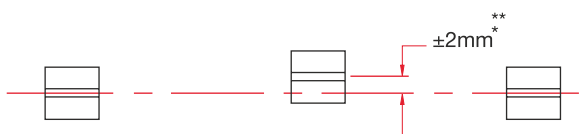

* ± 1 mm when the line of clips is set-out at the system dimension – 1 mm

** Under no circumstances should the distance between adjacent clips be less than the system dimension – 2 mm

Note: Industry research tolerance for standing seam systems - seek further advice from Kalzip technical for project specific queries

Variations between lines of clips-plan variations

It is recommended that lines of clips are set-out to the system dimension.

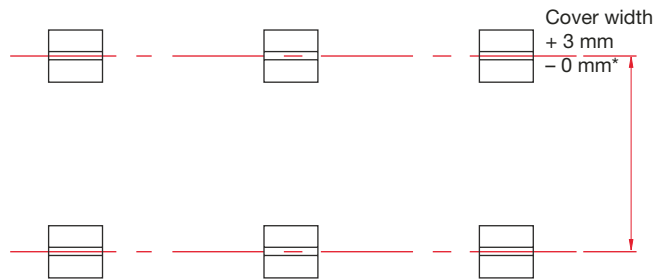

* 1 mm will be acceptable if limited to a small area of Kalzip sheets, e.g. when “closing” to a predetermined finishing point, gable etc.

Variations between lines of clips-plan variations

It is recommended that lines of clips are set-out to the system dimension. Structural support must be installed so as not to cause steps between clips.

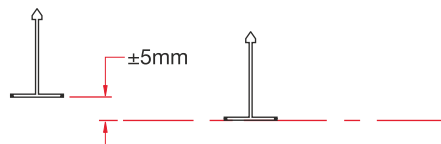

NB Applies to complete line of clips only.



Seam clips

The Kalzip standing seam system is extremely versatile and allows a comprehensive range of Kalzip accessories, such as walkways, handrails, steps, snow guards, photovoltaic panels etc to be safely installed without penetrating the weathering layer of the roof or wall.

The penetration free connection is achieved by the use of stainless steel or aluminium seam clips which clamp over the seam of the Kalzip sheet in order to

safely transmit the loading back to the substructure.

Extensive testing has been carried out on the range of Kalzip seam clips and their interaction with the Kalzip seams themselves.

The “actual” safe working loads for a seam clip are dependant upon the thickness and span of the Kalzip sheeting being used and are given in terms of loading per Kalzip seam per

Kalzip span rather than loading per seam clip.

For further information contact the Kalzip technical department.



Vapour control layer (VCL)

It is good practice to enhance the performance of a roofing system by incorporating a suitable vapour control layer (VCL).

A VCL will reduce the movement of water vapour from inside the building through the roof construction (thereby reducing the risk of condensation) and also assists in limiting air permeation through the system.

Kalzip VCLs are available as standard in either a clear 3 layer membrane for mid range applications (with humidity classes of 4 or below) or a foil encapsulated 5 layer membrane suitable for high humidity applications where a greater vapour resistance performance is required.

The VCL should always be installed on the warm side of the construction and should be continuous across its surface. It must be fully sealed at all laps,

perimeters and penetrations in order to ensure its effectiveness.

The type of VCL to be specified would be dependent upon the use of the building and therefore the condensation risk.

Air-tightness of a building is covered under the Building Regulations for England and Wales Approved Document L, and Technical Handbook 6 for Scotland.

Recommended Kalzip vapour control layer (VCL) for Kalzip roofing and cladding systems

Humidity Class ³	Typical building type	Kalzip VCL ¹ Liner/decking configuration	
		Solid liner	Perforated liner sheet and solid or perforated decking
1 Very low	Storage areas	Kalzip VCL clear with one row of Kalzip VCL sealing tape ²	Kalzip VCL clear with one row of Kalzip VCL sealing tape
2 Low	Offices, shops	Kalzip VCL clear with one row of Kalzip VCL sealing tape	Kalzip VCL clear with one row of Kalzip VCL sealing tape
3 Medium	Dwellings with low occupancy	Kalzip VCL clear with one row of Kalzip VCL sealing tape	Kalzip VCL foil with one row of Kalzip VCL sealing tape
4 High	Dwellings with high occupancy, sports halls, kitchens, canteens: buildings heated with unflued gas heaters	Kalzip VCL foil with one row of Kalzip VCL sealing tape	Kalzip VCL foil with one row of Kalzip VCL sealing tape
5 Very high	Special buildings, e.g. laundry, brewery, swimming pool	Kalzip VCL foil sealed with two rows of Kalzip VCL sealant tape	Kalzip VCL foil sealed with two rows of Kalzip VCL sealant tape

Notes:

1. The Kalzip VCL must be fully sealed at all side and end laps, penetrations and perimeter details to ensure the required level of air-tightness for the building envelope.
2. On humidity class 1 (very low) buildings where there is limited flashing details and penetrations it may be feasible to omit the Kalzip VCL. The Kalzip liner sheet should be fully sealed at all side and end laps, penetrations and perimeter in this instance.
3. Humidity Class of buildings taken from BS EN ISO 13788:2002 – Hygrothermal performance of building components and building elements – Internal surface temperature to avoid critical surface humidity and interstitial condensation – calculation methods.

Insulation

Kalzip insulation products are fully compliant with the harmonised European Standard BS EN 13162:2001 Thermal insulation products for buildings – factory made mineral wool products – specification.

All Kalzip insulants conserve energy through their use by reducing the requirement to heat or cool buildings, limiting CO₂ emissions.

As they are HCFC and HFC free and do not contain any of the gases that have been identified as having global warming potential (GWP) their ozone depletion potential (ODP) is zero and taking into consideration both manufacture and composition their GWP rating is less than five.

The most common insulation used is a quilt type, non-hygroscopic material (i.e. the Kalzip range of mineral fibre insulations) that will not absorb any moisture, but simply retain it on the surface of its fibres thus encouraging evaporation to take place.

The insulation is oversized to allow compression, reducing any air space between the top of the insulation and the underside of the Kalzip sheet. A major design feature of the Kalzip roof system is that no sealants are used in the formation of the standing seam, therefore making the outer skin of the roof build-up permeable to the passage of moisture vapour and allowing the Kalzip system to breathe.

The Kalzip standing seam is weather-tight by virtue of the anti-capillary groove situated within the formed seam, but is not airtight.

The use of a compressed insulation, completely filling the roof void above the vapour control layer, together with the breathability of the Kalzip sheet seams, negates the need for a breather membrane material within the Kalzip roof system.

Kalzip offers a wide range of insulation products for use as fully integrated components of Kalzip roofing and

cladding systems. The range includes glass mineral wool quilt and rock and glass mineral wool slab with ECOSE™ Technology, rock mineral wool quilt, semi-rigid slab and high density slab. At the heart of the range are Kalzip Insulation Plus 32, 35, 37 and 40, which are high performance mineral wool quilts offering extremely efficient thermal performance.

To complete the range further, glass and rock mineral wool insulants are available offering a wide variety of thermal performance values together with the flexibility of use where additional acoustic performance is required, or where a rigid insulation material is necessary to support the forming of details and interfaces at soaker positions, welded laps and ridge position of curved sheets.

The details can be found by referral to the Kalzip standard and typical details brochure and CAD compatible CD ROM.

ECOSE™ Technology

ECOSE™ Technology is a revolutionary, bio-based, formaldehyde-free binder technology, based on rapidly renewable materials instead of petro-based chemicals. It reduces embodied energy and delivers superior environmental sustainability.

For further information contact the Kalzip Technical Department.

Kalzip Supakube

The Supakube is revolutionising the way that we package our insulation materials and offers many significant advantages and cost savings over the more traditional methods.

Providing a full, waterproof hood covering for both the insulation and the pallet it substantially increases truck capacities (improving load utilisation) reduces manual handling, improves overall production efficiency and facilitates off loading and storage on site.



Project: Mountbatten Leisure Centre, Portsmouth, UK
Architect: Saunders Architects LLP



Project: RAF Cosford, UK
Architect: Feilden Clegg Bradley



Project: Cooper's Road, London, UK
Architect: ECD Architects



Project: Lesmahagow High School, Scotland, UK
Architect: Aedas Architects



Kalzip fall arrest systems

Kalzip fall arrest systems (for straight and tapered Kalzip sheets) have been specifically designed using advanced technology and has been fully tested and proven for use on the Kalzip standing seam system. The constant force post and base are manufactured from zinc coated mild steel with the domed cap of the post and all internal performance components made from 316S marine grade stainless steel.

Workers wearing a full body harness lanyard attach themselves to the Kalzip safety systems using a Transfastener which slides smoothly along the stainless steel cable enabling the person to operate handsfree.

In performance terms the post has an integral high capacity energy absorbing coil which is designed to reduce loads in a fall situation to a maximum of 10kN.

This means that the post nearest to the incident absorbs the impact without transferring the load across the rest of the fall arrest system or onto the roof structure itself. This advanced capability allows up to three people to be linked to the system at any one time.

The neat cylindrical design is unobtrusive and both the post and the base plate can be colour coated to match the Kalzip sheet. Installation and fixing is via special clamps that fix the post to the standing seam; no penetrative fixings are required and the integrity of the roof is preserved.

Kalzip fall arrest systems are custom designed for each project, using computer design software. This unique Windows® software package models and calculates loadings to determine optimum spacing for the posts.

Kalzip fall arrest system's installation, maintenance and routine certification is carried out only by our approved Kalzip height safety specialist network.

Benefits include:

- Neat, unobtrusive appearance
- Available colour coated
- Integral load absorbing capacity
- 3 users at any one time
- Non-penetrative fixings
- Tested and approved for use on Kalzip aluminium standing seam
- CE marked
- Conforms to BS EN795

Kalzip grillage walkway and handrail system

The Kalzip grillage walkway and handrail system is a modular system manufactured from extruded aluminium components. It offers a lightweight, durable, self-draining, low maintenance construction for simple and quick installation to the Kalzip standing seam roof system.

Extruded aluminium seam clips ensure a secure fixing method to the Kalzip seams without penetrating the sheets.

Walkway grillage

The walkway grillage is supplied in modular lengths to suit the cover width of the Kalzip sheet and consists of 25 mm deep non-slip load bearing extruded aluminium bars joined using the unique swage lock method of construction.

The bars – in a nominal 30 x 100 mm mesh pattern spanning transversely across

the width of the walkway – are set into 65 mm deep side 'z' section members.

The walkway grillage is available in 600 mm and 900 mm wide panels with other widths available if required. Lengths of the walkway grillage can be easily cut to suit, on or off site, if size adjustment is required without any detriment to the walkway construction.

The Kalzip grillage walkway can be installed with handrails to both sides, one side only or without handrails.

Roof pitch

The system can be installed in plane to the roof at pitches up to 10°. Above this can be accommodated by stepped units.

Where a flat and level surface is required special clip extension pieces are utilised to counter the roof pitch.



Kalzip suregrip walkway

The Kalzip Suregrip UPVC roof walkway system provides anti-slip walkways across roofs, for access and maintenance traffic. The system consists of an assembly of extruded PVC-U, moulded PVC-U and stainless steel components. The plank components are manufactured with a patterned surface to give improved slip resistance in dry and wet weather and meet the requirements of the following:

- HSG33 Health and safety in roofwork
- The Construction (Health, Safety and Welfare) Regulations 1996 – Regulations 5 and 6
- Workplace (Health, Safety and Welfare) Regulations – Regulation 13
- Scotland - Regulation 27, Standard P2.8

Tests to BS 476 : Part 7 : 1987 Fire Tests on Building Materials and Structures – Method for classification of the surface spread of flame of products show that the PVC compound used to manufacture the Kalzip Suregrip Walkway System is classified:

- Class 1Y

Durability

The Kalzip Suregrip walkway system, when subjected to normal conditions of exposure and use, will retain integrity for a period in excess of 25 years. The white PVC compound is UV stabilised and will remain colour stable over an extended period of time.

Finish

Available in white and grey.

Further details on Kalzip walkways are available on request.



Kalzip fabrications and associated products

Gutters and fittings

Lightweight, yet exceptionally strong, Kalzip gutters are available in two options - a single skin aluminium or membrane gutter for applications where no U-value is required and a Kalzip insulated membrane lined gutter, which meets building regulation U-values of 0.25W/m²K.

Single skin gutter

The single skin gutter can be fabricated as standard in lengths of up to 6 metres (although lengths of 8.5 metres are achievable depending on the application) reducing the number of fixings required and minimising the possibility of leaks. Factory fitted dilaprene expansion joints are also available, which contribute to costs savings on site.

Membrane-lined gutters

(both TPO & PVC options are available)

Combining the advantages of lightweight metal and insulation sandwich construction, the Kalzip TPO composite gutters are designed for use in commercial and industrial applications. The Kalzip gutter is fully lined and jointed with a membrane, which gives it the flexibility to be used for both eaves and valley details.

Environmentally friendly, a 1.2 mm thick membrane is factory bonded to a 1.2 mm gauge hot dip galvanised steel substrate to BS EN 10326, giving a highly durable product with a weather resistant surface. The unique synthetic

rubber formulation provides excellent colour stability and resistance to ultraviolet light, heat, harsh weather conditions including ponding water and general wear and tear.

The standard coil width is 1250 mm (up to a maximum of 1450 mm) and is foldable to an angle of 90°.

The system is installed using established 'single ply' heat seaming techniques with the major benefit of operating at significantly lower temperatures than conventional PVC membranes. Butt-strap joints are secured with low profile rivets, covered with jointing membrane and hot-air welded to give a strong, durable and water-tight connection.

The specially formulated Kalzip synthetic rubber membrane does not deteriorate or release harmful chlorofluorocarbons into the environment. It is also safer for the installer because of lower hot-air welding temperatures and the absence of irritant gaseous emissions. Product COSHH safety information sheets are available. See KZ-HSENV-COSHH-TPOM-1018.

Insulated option

The core of the insulated gutter is rigid polyurethane (PU) foam, which is loose laid between the inner and outer skin; the flanges of each skin are overlapped

and secured with rivets; approved by both Factory Mutual and the Loss Prevention Council.

The inner lining of the gutter can be provided to suit project-specific requirements but would typically consist of a 0.7 mm galvanised steel sheet with or without a polyester paint coating.

To achieve an elemental U-value of 0.25W/m²/K a core thickness of 90 mm is required.

Accessories

A full range of Kalzip accessories can be supplied for membrane-lined gutters including:

- 180 mm x 30 m jointing membrane (other widths also available)
- Internal and external pre-moulded corners
- Pre-moulded outlets (conical and flush)
- Leaf guards (conical and flush)
- Outlet to down pipe expansion seals
- Polyester powder coated aluminium down pipes, colour-matched to other flashings



Standard and custom made flashings

Offering aesthetic details at roof to wall junctions, there are three types of Kalzip flashings in the range - standard, curved and custom-made - all of which are carefully engineered to specific design requirements to eliminate potential performance problems.

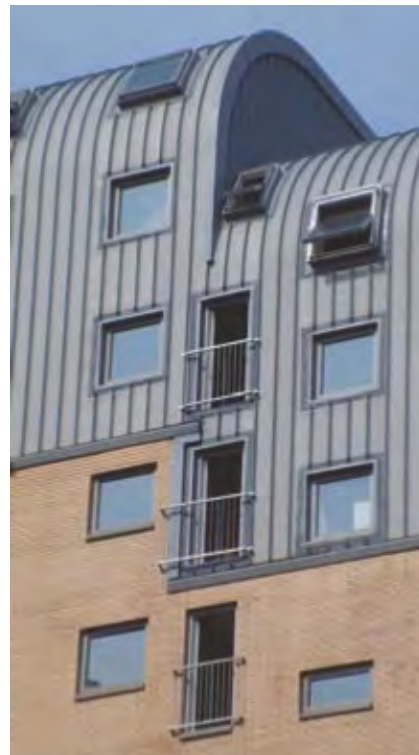

Rainwater pipes and accessories

Combining functionality and practicality, there are three designs of rainwater pipes – round swaged, square swaged and anti-vandal.

The round and square swaged designs are available in the following dimensions:

Square

76x76mm, 102x102mm and 150x150mm

Round

76mmØ, 102mmØ and 150mmØ

All three designs are available in mill finish, post-coated polyester and PVdF, to complement the overall building design.

A full range of rainwater accessories is also available.



Bullnoses and column casings

Kalzip bullnoses and column casings are available in a variety of shapes and sizes to complement any building design.

Bullnoses

Generally specified at eaves level, Kalzip bullnoses are equally well suited for use at ridge level to provide a striking finish to the building.

Bullnoses can be produced from a maximum 3 mm gauge and up to a length of three metres. Manufactured from a maximum standard coil girth of

1500mm, a large range of radii can be achieved, with individual specifications available on request.

Bullnoses and gutters can even be incorporated into one piece to provide a more cost-effective solution and reduce the quantity of flashings and butt straps required.

Column casings

Functioning as an aesthetic covering for primary steelwork, Kalzip column casings add a stunning feature to any

building. The durable Kalzip material will assist in protecting the structural steel from aggressive conditions, including atmospheric and chemical attack.

Column casings can be either machine or hand crafted, depending on requirements.



Copings and cappings



Kalzip copings and cappings can be used in a wide variety of applications to decorate a range of wall systems. From parapets disguising unsightly plant equipment on shallow-pitched roofs, to assisting a practical weatherseal or creating an eye-catching feature, Kalzip's coping system is available in two types of alloy and various coated finishes to suit the client's individual requirements.

Improved visual effect

Straight or curved in detail, Kalzip copings and cappings can be 'secret-fixed' with an underfix bracket system to improve their visual effect and are available with prefixed butt straps and interlocking straps to negate the need for face fixing.

They can also be specially manufactured to meet an individual's details to include welded mitred corners and stop ends for a durable, yet streamlined effect.

The Kalzip aluminium coping system is produced in aluminium to the following specifications:

- BS EN AW-3004 (AlMn1Mg0.5) and
 - BS EN AW-3005 (AlMn1Mg1)
- To **BS EN 485-4**, **BS EN 508-22** and **BS EN 573-3**.

The copings are of a standard 3 metre in length, with bespoke sizes available on request.

Kalzip aluminium coping system is available in plain aluminium or post-coated with polyester or PVDF paint finish.

Planking system

Providing a weathering, durable and visually appealing finish to complement the building, the Kalzip planking system can be utilised within fascia, soffit and walling details.

This is a site-assembled system using the same elements as the double skin system but with an outer plank profile sheet that can be fixed horizontally, vertically or diagonally. The panels are generally produced with a solid surface; however it is possible to produce special panels. These can be perforated, tapered or even cranked.

The sheets are fastened to purlins or top hat sections supported by the main framework. In horizontal or near horizontal installations the sheets must be correctly oriented to prevent water

being retained on the lapping flange. The advantage of hidden fixings reduces the risk of water penetration.

The Kalzip planking system can be fabricated in a variety of materials and finishes including mill finish or painted aluminium, AluPlusZinc and Falzinc. The cover width and gauge must be considered before specification takes place.

The panels are available in lengths of up to 6 metres in most Kalzip materials and finishes. Preformed junction pieces and profiles fillers are used where runs end and exceed the maximum length.

Variable cover widths can be produced depending on the material gauge, type, grade and application used.

The Kalzip planking system is also available as a press-formed single skin flat aluminium panel which can be used as the outer skin of a rainscreen wall and is available in a range of cover widths depending on the material gauge.

The panels can also be perforated in the main flange, filled with stone wool insulation and fixed to the underside of structural metal decking as an acoustic ceiling. Further details are available on request.

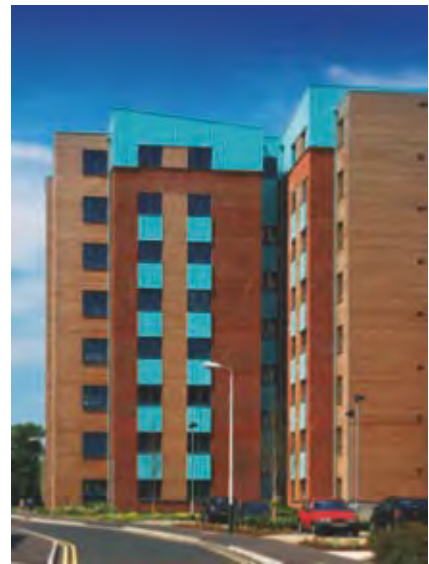

Snow guards

Whilst snow sliding from metal roofs will reduce the loads on them, it also causes considerable damage to gutters and other roof accessories.

High performance

Kalzip's high performance snow guards are designed and manufactured to meet customers' specific requirements

and can include two, three or four specially-designed fingers to suit the pan of the roofing sheet.

The guards are secured to the roof surface with specially designed Kalzip seam clips, removing the need for roof penetrations, thereby maintaining the system's integrity.

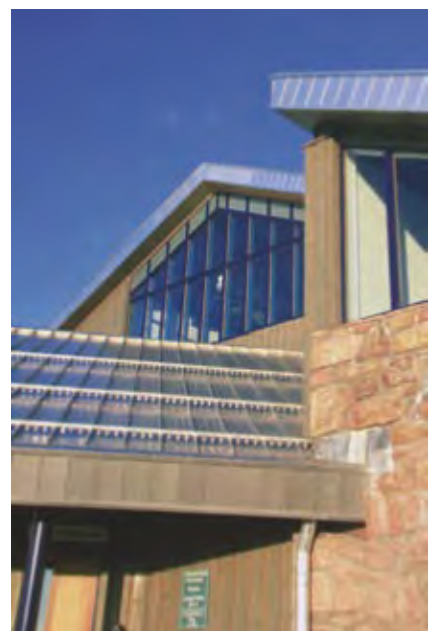

Rooflights for Kalzip

In a well designed building roof lights have a major impact on overall energy use. Research demonstrates that installing 15-20% rooflight area can greatly reduce a building's total CO2 emissions.

Regulations Revised Part L of the Building Regulations 2006

Part L is concerned with saving energy and minimising associated CO₂ emissions. Use of natural daylight through 15-20% rooflights is a practical solution to ensuring the lighting levels within a building are adequate, and will dramatically reduce the artificial lighting requirement, often the biggest use of energy when operating a building, particularly when automatic lighting controls are used.

The 'notional building' used in Part L Regulations assumes 20% rooflight area and research demonstrates that installing less than this amount will make compliance more difficult.

Part L also sets a minimum performance standard for rooflights of 2.2W/m²K, which requires triple skin rooflights.

Workplace (Health Safety & Welfare) Regulations 1992 – Regulation 8

“Every workplace shall have suitable and sufficient lighting....(which) shall, so far as is reasonably practicable, be by natural light.”

MCRMA Technical Paper No.1: Recommended Good Practice for daylighting in metal clad buildings

“As a guide...satisfactory results can generally be achieved with roof light areas up to 20%.”

Benefits of rooflights

Rooflights don't just improve the external environment, they improve the internal environment too.

People prefer natural light to electric light and there is a growing body of scientific evidence to suggest that it helps us perform better.

Studies have shown that school children learn better, hospital patients recover faster, factory workers are more productive and shoppers linger longer, spending more.

Profile designed to fully integrate into the Kalzip system, at 400mm or 800mm widths. Suitable for curved roofs down to a minimum radius of 70 metre.

Unique 'Hardpak' rigid fillers can be supplied, to ensure fast, reliable, leak-proof fixing. They provide robust support at intermediate purlins to enable crown fixings for low pitch roofs and over the apex of curved roofs.



Kalzip Multivault SSR

Kalzip multivault SSR polycarbonate barrel has been designed to fit directly onto standard verge closure components for the Kalzip system, so no structural kerb is required. Engineered to maintain complete roof integrity, as in 'secret fix' design, the fixings don't pierce the sheeting. To ensure long term safety, single skin SSR roof lights are typically installed on site with a GRP in-plane liner to achieve Class B non fragility. Triple skin options give low U-values as required by Part L.

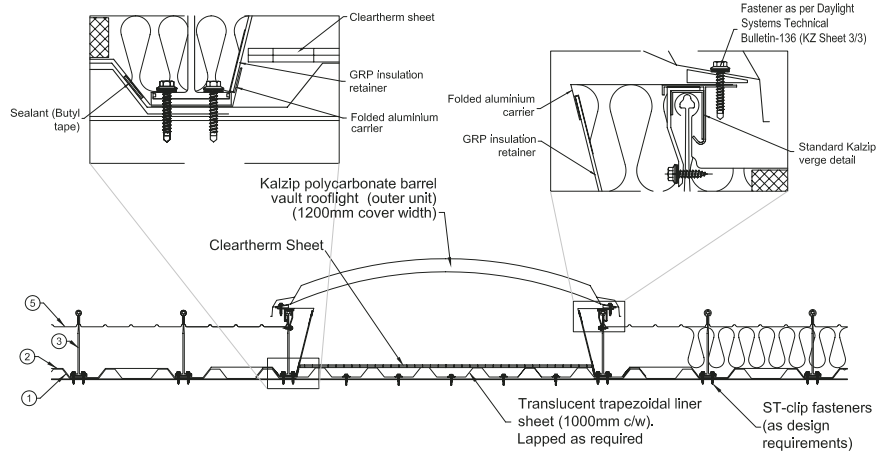

Kalzip Multivault GRP

Kalzip multivault GRP barrel vault is recommended when roof light widths other than 1200 mm are required. It is engineered to suit spans in any width up to four metres. Ideal for use in triple skin applications, as the factory assembled double skin barrel installs quickly and easily over a GRP in-plane liner.

Kalzip multivault GRP maintains complete roof integrity as kerb fixings don't pierce the sheeting. No other fixing is required on spans up to 1500 mm. For spans over 1500 mm, barrels include aluminium fixing channels over the void for full water management.

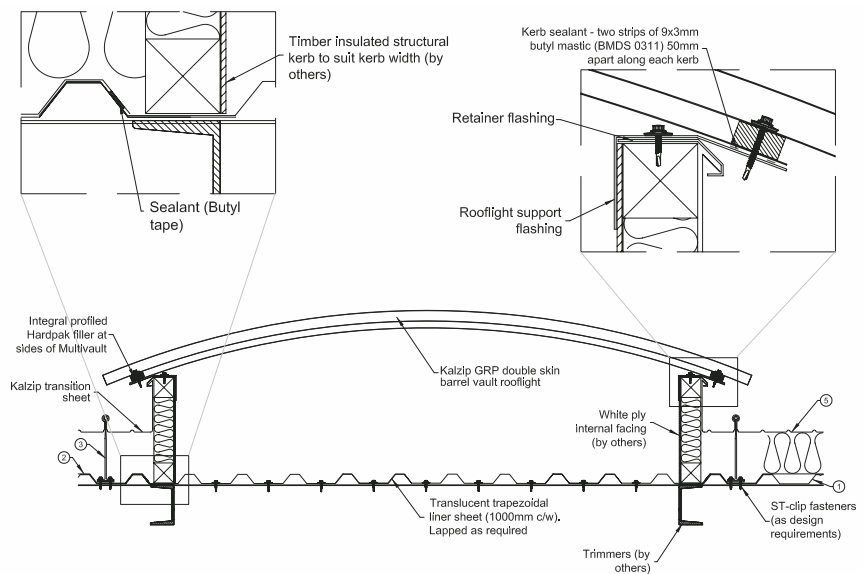

Kalzip GRP in-plane site assembled

Kalzip GRP in-plane site assembled roof lights fit below the seams of the roof, making them almost invisible from the ground. This site assembled roof light is a very economic solution for Kalzip systems. Part L option achieves U-values of 1.3, Class B non-fragile to ACR[M]001:2005.

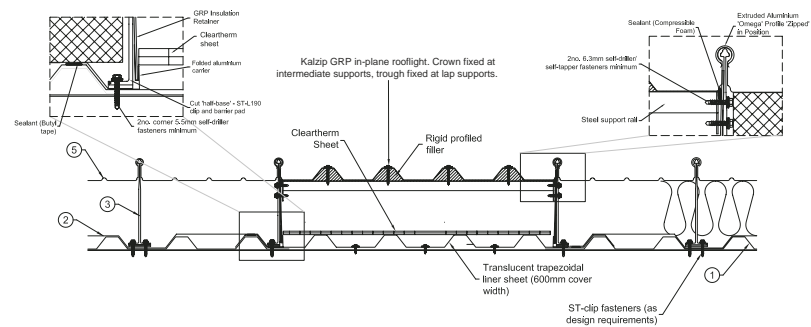

Kalzip GRP in-plane factory assembled

Kalzip GRP in-plane factory assembled roof lights fit below the seams of the roof, making them almost invisible from the ground. This factory assembled roof light is a very economic solution for Kalzip systems. Part L option achieves U-values of 2.2, Class B non-fragile to ACR[M]001:2005.

Profile designed to fully integrate into the Kalzip system, at 305 mm or 400 mm widths.

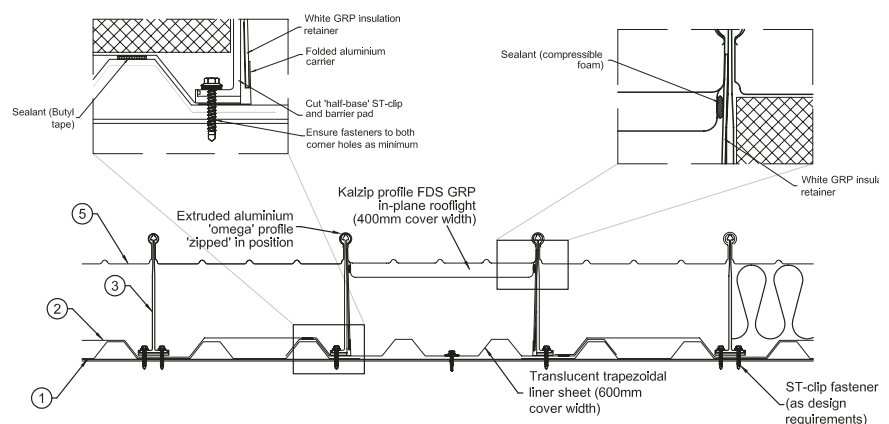

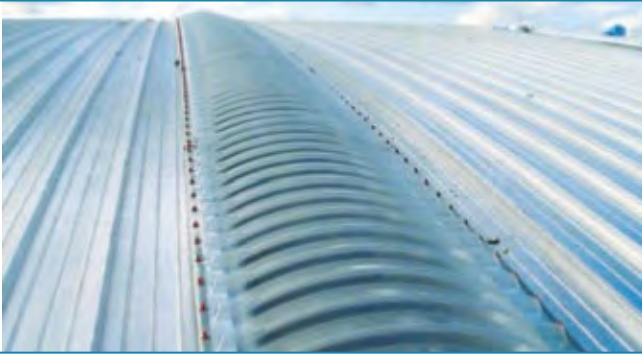

Polycarbonate barrel vault



GRP barrel vault

Kalzip multivault SSR

Ideal rooflights

Design	For installation directly onto standard Kalzip verge closure components. No structural kerb required. Site assembled, polycarbonate barrel. Unique apex adapter and jointing system, for simple, accurate installation.
Width	1200mm
Min Radius	30m
Glazing	Triple skin light transmission: 60-65% (clear polycarbonate barrel with a GRP 3.0kg/m ² liner) and Cleartherm2 intermediate sheet
Fire Ratings	Outer: deemed SAA Inner: Class 1 surface spread of flame
Safety	Non-fragile to ACR[M]001:2005. Class B: when specified with an appropriate liner. Single skin: Class C We recommend 3.0kg/m ² GRP liner to match the Class B non-fragility rating of the metal liners. In order to utilise the full width of the SSR barrel, 1400 mm wide GRP liners are recommended.
Part L	Triple skin: U-value 1.3 W/m ² K. Polycarbonate barrel over a separate GRP in-plane liner with Cleartherm2 intermediate sheet.

Kalzip multivault GRP

GRP for unusual spans

Design	The Kalzip GRP Multivault rooflight is installed on a structural kerb upstand arrangement, for all span conditions. Robust double skin factory assembled barrel with well fitting insulated aluminium end closures.
Width	Any width up to 4m
Min Radius	70m (depending on width)
Glazing	Double skin light transmission: 65-70%
Fire Ratings	Outer: SAB Inner: Class 1 surface spread of flame
Safety	Non-fragile to ACR[M]001:2000 Class B
Part L	Triple skin: U-value 2.0 W/m ² K Double skin barrel with a GRP in-plane liner panel
Fixing	Up to 1500mm span: no 'over-void' fixing gives increased safety, water-tightness and speed of installation. Span widths greater than 1500mm require fixing across the span: barrels incorporate an aluminium cross member, with integral drainage channel to direct any water outside the void. For installation at these widths 'over-void' access may be required.



GRP site assembled

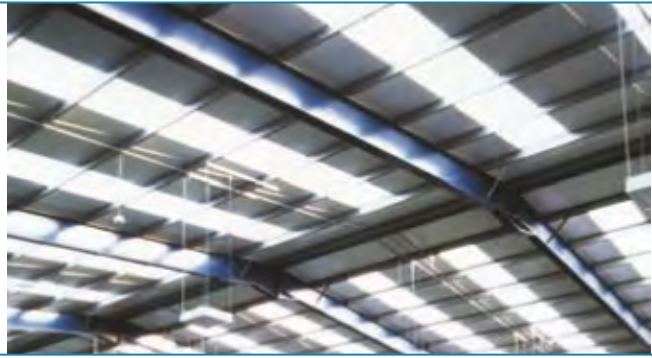

GRP factory assembled

Kalzip in-plane site assembled GRP

In-plane and visually discrete

Design	For fully integrated installation into Kalzip system. No special tools needed. Visually discrete, In-plane, site assembled rooflights.
Width	400mm, 800mm
Min Radius	70m
Glazing	Double skin light transmission: 65-70%
Fire Ratings	Outer: SAB Inner: Class 1 surface spread of flame.
Safety	Non-fragile to ACR[M]001:2000 Class B: when specified with a heavyweight liner Single skin: Class C We recommend: 3.0kg/m ² GRP liner to match the Class B non-fragility rating of the metal liners.
Part L	Triple skin: U-value 2.0 W/m ² K Double skin GRP with Cleartherm intermediate
Fixing	Trough fix at end laps. Crown fix (through unique 'Hardpak' rigid profiled fillers), over crown of curved roof. Trough or crown fix at intermediate purlins at 50° pitch or greater.

Kalzip in-plane factory assembled GRP

In-plane and visually discrete

Design	Factory assembled double skin rooflight for installation over separate In-plane liner to create a triple skin rooflight. Avoids through fixings except at endlaps. Only suitable for single width applications (up to 400mm wide); not suitable for curved roofs.
Width	305, 400mm
Min Radius	Not suitable for curved roofs
Glazing	Double skin GRP factory assembled over separate GRP liner, overall light transmission: 45-50%
Fire Ratings	Outer: SAB to BS476 Part 3 Inner: Class 1 to BS476 Part 7
Safety	Correctly specified in-plane liner will achieve Class B to ACR[M]001:2000 We recommend: 3.0kg/m ² GRP liner (600mm cover) to match the Class B non-fragility rating of the metal liners.
Part L	Triple skin: U-value 2.0 W/m ² K Double skin rooflights over separate liner
Fixing	Follow our recommendations for securing rooflights to Kalzip using 'Omega' cover cap at each side. No additional fixing needed at intermediate purlins. Follow our fixing details for sealing and fixing of endlaps; rooflights incorporate metal reinforcement to accept endlap fixings.



Project: Spazio Health Club, The Netherlands
Architect: Frits van Donga

Materials and finishes

Kalzip roof and cladding systems are available in a host of finishes and materials. In addition to aluminium, the system is offered in special finishes like AluPlusZinc or AluPlusPatina as well as standard stucco-embossed finish.

With the very latest surface finishing and processing technology Kalzip offers an almost unlimited choice of colours in a range of effects and finishes.

Colour-coated Kalzip aluminium products meet the stringent demands of modern building technology and design with regards to colour fastness, adhesion and resistance against aggressive substances and environments, and are available in a wide variety of standard RAL colours with a choice between high quality polyester or PVdF coatings.

Together with aluminium, Kalzip in stainless steel and copper give even more choice to the discerning architect or planner.

Kalzip foldables for traditional raised seam systems (Falzinc & TitanSilver)

Falzinc is a lightweight, foldable aluminium material with a durable zinc top layer, whose fusion perfectly combines advanced product properties with skilled traditional installation techniques.

With its distinctive and mature appearance Falzinc represents an alternative approach to roofing and facade design whether for new build or refurbishment it is suitable for a broad range of applications. Ideal for high quality skilled metalworking the material can be folded, edged, flanged and welded with precision even under unfavourable conditions e.g. low outside temperature. The material is also available in a TitanSilver finish.

For further information or to receive a copy of the dedicated Falzinc brochure visit www.falzinc.com



Materials and finishes



Project: City of Manchester Stadium, UK
Architect: ARUP Associates



Project: Cramlington Junior Learning Village, Northumberland, UK
Architect: Space Architecture

Natural aluminium

Kalzip standing seam and profiled cladding sheets are available as standard in a stucco embossed finish which is achieved by processing the natural mill finish material through embossing rollers. This provides a surface which diffuses light reducing reflectivity and glare.

As aluminium is both a stable and durable material, it provides excellent service as a roofing or cladding without the need for any protective coating.

After prolonged exposure to the elements, the original highly reflective surface of aluminium will dull down to a uniform patina finish and changes in appearance will be consistent along any elevation.

The weathering effect is particularly well illustrated on the City of Manchester Stadium. In the space of just 12 months the original roof had dulled down. Once the new North Stand was installed it too started to lose much of its high reflectivity and toned down to match the original Kalzip material.

For specifications that can not wait for nature to take its course and want an instant matt grey appearance, such as buildings close to airports or roads, there is a pre-weathered finish available in the form of AluPlusPatina.

Colour coated aluminium

Although, in the majority of cases, aluminium provides excellent service without the need for any protective coating, there are applications where the metal requires protection against a particularly aggressive environment or the client simply requires colour.

Reasons why a user may choose to specify a coating on their systems is that colour may be required to match existing buildings, to comply with building requirements or to conform with the customer's visual expectations or it may be that the use of infra-red paint may be required to aid reflectivity.

Kalzip profiled sheets are available in three standard pre-coated systems:

- Polyester coil coated
- Abrasion resistant coated (ARS)
- Polyvinylidene fluoride (PVdF)

Decorative and ultimate life spans

System	Decorative life*	Ultimate life
Polyester	10	30 +
Polyester powder	15	30 +
ARS	15	30 +
PVdF	20	30 +

*Decorative life is given for typical industrial environments; these figures may be extended for rural applications

Performance	PVdF	ARS	Polyester
Scratch resistance	G	E	G
Stain resistance	E	G	G
Colour fastness	E	G	G
Weathering	E	G	G
Chalking resistance	E	G	M

E = Excellent G = Good M = Moderate

AluPlusZinc

Kalzip AluPlusZinc offers all the performance benefits of traditional aluminium together with the aesthetic appeal of zinc. The unique patented PEGAL process produces a highly durable fusion between the aluminium substrate and the thin zinc layer eliminating most of the corrosion problems associated with zinc, allowing simpler and more cost effective roof constructions to be created.

Benefits at a glance

- Lightweight yet strong material
- Speed of installation compared with traditional systems
- Non-ventilated, warm roof construction
- Complementary associated flashings
- Trained installer network



Project: Filhet Allard Restaurant, France
Architect: Luc Arsene-Henry Jr

AluPlusPatina

Kalzip AluPlusPatina provides an attractive metallic design option with a high quality, matt appearance.

The pre-weathered profiled sheets are made from stucco embossed aluminium with additional surface treatment. With this treatment, the aluminium surface loses its natural shine and significantly reduces reflection - by up to 20% in some cases.

The characteristics of this surface finish are comparable to those of an aluminium profiled sheet which has been weathered over years.

The product advantages

- A robust surface which is highly resistant to weathering
- Significantly reduced light reflection
- Pre-weathered surface creates an elegant and matt appearance
- Ideal for cladding
- High level of inherent stability makes it suitable for large spans
- A variety of profile forms are available
- Sophisticated detailed solutions and fittings

Copper

Copper Kalzip combines the aesthetic and durable properties of copper with the added benefit of low costs over the material's lifespan.

It is an exceptionally strong, anti-corrosive and virtually maintenance-free material with an initial bright appearance that weathers gradually to mellow bronze tones through to a rich green patina in roofing and anthracite brown in vertical applications.

Unexposed	4 months	8 months
1 year	2 years	3 years
4 years	5 years	7 years
10 years	25 years	25-30 years



Project: Burns Monument Centre, Scotland, UK
Architect: East Ayrshire Council



Project: Amsterdam Architecture Centre, The Netherlands
Architect: René Van Zuurk

Stainless steel

The Kalzip standing seam roofing and cladding system can be supplied in austenitic stainless steel - a long life, low maintenance and corrosion resistant building material available in more than one finish.

A wide range of stainless steel fabrications is available to fully support a roof or wall specification.



Project: Arndale Centre, Manchester, UK
Architect: Chapman Taylor Architects

Material	Material gauge	Profiles
Natural & colour coated aluminium	0.9 mm, 1.0 mm, 1.2 mm	50/333, 50/429, 65/305, 65/333, 65/400, 65/500
AluPlusZinc	1.0 mm	65/400, 50/429 and AF65/434 as standard
AluPlusPatina	1.0 mm	65/400, 50/429 and AF65/434 as standard
Copper	0.8 mm	65/400
Stainless Steel	0.6 mm, 0.7 mm	50/333, 50/429, 65/305, 65/333, 65/400, AF65/333, AF65/434

Project: Stafford Leisure Centre, Staffordshire, UK
Architect: Barnett Ratcliffe



System design guidelines and performance characteristics

Kalzip has developed system design, specification and product innovation to guarantee compliance with the latest Building Regulations without any compromise to the overall performance capabilities or aesthetic potential of its products.

With proven durability and high performance, Kalzip has the capacity to meet the complex and rigorous requirements of the most challenging buildings. Being a multi-component built up system, Kalzip can be precisely tailored to meet the needs of the individual project – addressing prime concerns, such as corrosion resistance, sound reduction/absorption, thermal performance or condensation control – in addition to other fundamental performance requirements such as load span capability.

Performance of the system was established by the unique ‘zip’ technology – ensuring a weather tight seam which also allows the roof to breathe naturally.

A non-penetrative, patented clip ensures smooth thermal cycling of the external sheet over the clip head whilst at the same time facilitating outstanding spanning capacity under high wind loading. Combined with Kalzip’s pioneering on-site roll-forming capability we can provide continuous single sheet lengths in excess of 150 metres without end laps or surface penetration by fasteners.



Product parameters

The flexibility and ductility of aluminium makes Kalzip the perfect roofing sheet for beautifully curved and tapered designs.

Kalzip roof sheets can be produced with a convex or concave radius utilising 3 methods:

- **Natural curved**
 - minimum convex radii 40 metres to 52 metres subject to gauge & cover width
 - minimum concave radii 45 metres to 60 metres subject to gauge & cover width
- **Machine curved (smooth curved)**
 - special curve minimum radii 1.5 metres with two straight legs, which have a minimum length of 400 mm, subject to profile, gauge and finish
- **Crimp curved**
 - minimum radii 0.485 metres - convex only
 - maximum sheet length 7.5 metres

Natural curving

Parameters

Kalzip profile (mm)	Gauge (mm)	Support spacing L(M)	Convex radius Ri(M)	Concave radius Ri(M)
305	0.9	1.6	40	45
up to	1.0	1.8	45	50
500	1.2	2.0	52	60

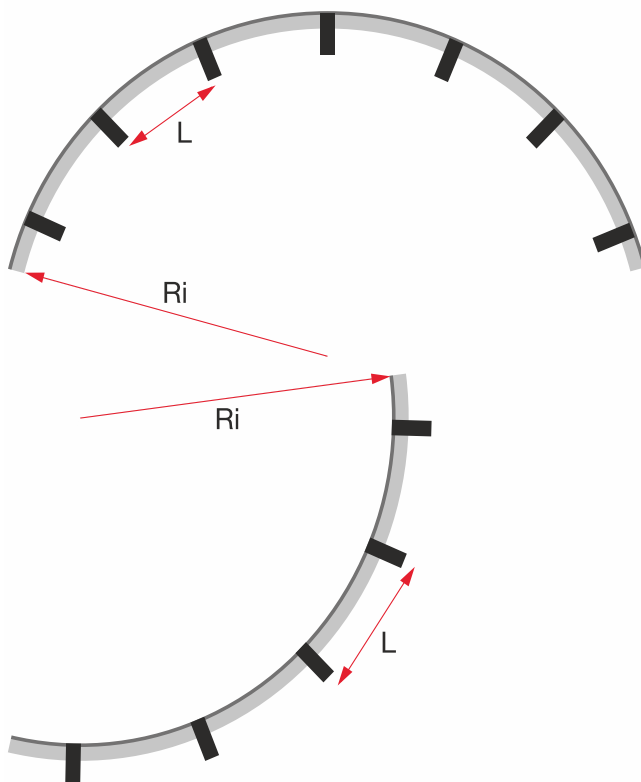

Factory curved (standard)

The following applies to all forms of machine curved profiles:

- Curves are produced with two straight legs, which have a minimum length of 400 mm
- Maximum sheet length subject to radius required, handleability and transportation
- Minimum sheet length 1.5 metres

Concave curving

Kalzip profile	0.9 mm	1.0 mm	1.2 mm
65 std profiles	16.0	12.0	10.0
50 std profiles	12.0	9.0	8.0
AF std profiles	16.0	12.0	10.0
AS std profiles	20.0	18.0	14.0

Convex curving

Kalzip profile	0.9 mm	1.0 mm	1.2 mm
65 std profiles	7.0	3.0	2.5
50 std profiles	7.0	2.0	2.0
AF std profiles	10.0	6.0	5.0
AS std profiles	20.0	14.0	10.0

Waveform - concave / convex or convex / concave

Kalzip profile	0.9 mm	1.0 mm	1.2 mm
65/305	20.0m + 20.0m	16.0m + 16.0m	10.0m + 10.0m
65/333	20.0m + 20.0m	16.0m + 16.0m	10.0m + 10.0m
65/400	20.0m + 20.0m	16.0m + 16.0m	10.0m + 10.0m
65/500	20.0m + 20.0m	16.0m + 16.0m	10.0m + 10.0m
50/333	20.0m + 20.0m	16.0m + 16.0m	10.0m + 10.0m
50/429	20.0m + 20.0m	16.0m + 16.0m	10.0m + 10.0m
65/333 AF	20.0m + 20.0m	16.0m + 16.0m	10.0m + 10.0m
65/434 AF	20.0m + 20.0m	16.0m + 16.0m	10.0m + 10.0m

NB - For radii outside the above parameters please contact the Kalzip technical department.

Tapering

Tapered convex

Kalzip profile	0.9 mm	1.0 mm	1.2 mm
50 std profiles	10.0	6.0	5.0
65 std profiles	10.0	7.0	7.0

Tapered concave

Kalzip profile	0.9 mm	1.0 mm	1.2 mm
50 std profiles	12.0	10.0	10.0
65 std profiles	10.0	9.0	9.0

Site curving

Site curving is also possible subject to space availability.

Please contact the Kalzip technical department for further details.



Project: Diamond Synchrotron, Didcot, UK
 Architect: Crispin Wride Architectural, Design Studio at Jacobs Engineering

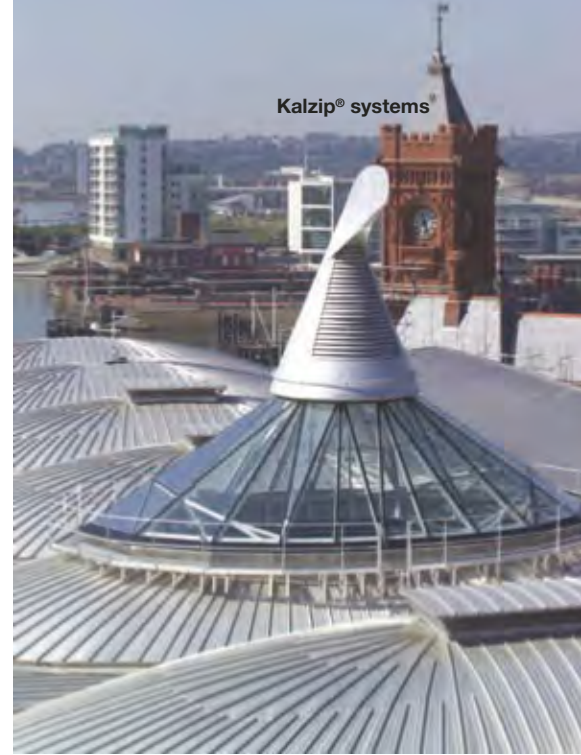

Project: Welsh Assembly, Cardiff, UK
 Architect: Richard Rogers Partnership

Tapered sheets

Tapered Kalzip profile sheets have become increasingly significant for roofing applications as they can be formed into a diverse range of shapes. A roof can offer more than just protection: it can give the building architectural perfection. For a perfect construction some fundamental aspects have to be observed. The minimum and maximum cover widths are between 225 mm and 620 mm.

Tapered Kalzip sheets have to be installed on the roof by following the precise instructions laid down in the relevant installation plan.

It is advisable to check the actual dimensions of the substructure against the dimensions on the installation plan before the production is started.

The bottom sheet must be supported by an insulation material of sufficient compressive strength if the taper size exceeds 400 mm. To achieve the required stiffness of the bottom sheet at the eaves end of the sheet, the incorporation of an eaves angle is essential. For double skin constructions we recommend the use of structural or liner deck.

	Kalzip 65 and 50	Kalzip AF
Minimum construction width	225 mm	170 mm
Maximum width	620 mm*	620 mm
Minimum length	1500 mm	1500 mm
Maximum length	Dependent on transport	Dependent on transport
Gauge	0.9 - 1.2 mm	0.9 - 1.2 mm
Curved and tapered	Possible for construction widths of 225 mm to 620 mm max. Only following approval from the technical department.	

* Maximum width for AluPlusZinc, AluPlusPatina, stainless steel and copper is 400 mm.

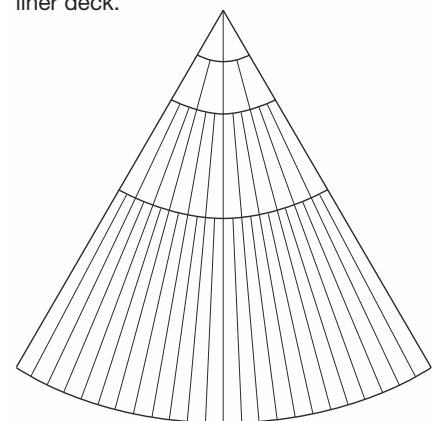
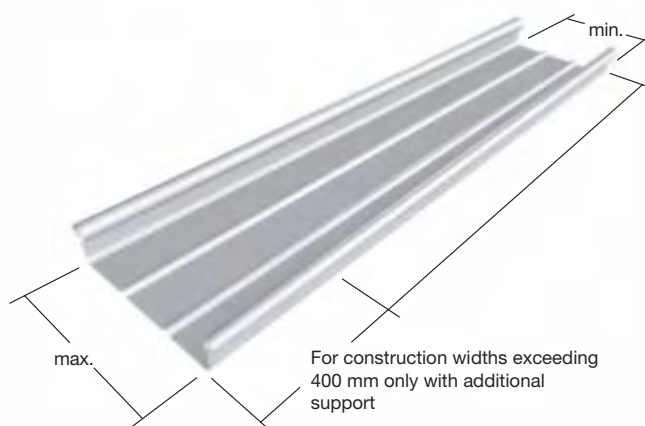

Sheet layout example with joints
 Self-supporting up to a pan width of 400 mm

Finishes:

- Stucco-embossed
- AluPlusPatina*
- Coated material (with protection foil)
- AluPlusZinc (with protection foil)*
- Stainless steel*
- Copper*

* Maximum width for AluPlusZinc, AluPlusPatina, stainless steel and copper is 400 mm.



Long length Kalzip

Kalzip sheets are commonly used in long lengths (with continuous lengths in excess of 150 metres being achieved) therefore the understanding and control of thermal movement is a prime consideration.

Thermal movement

The colour and finish of a roof will also play an important role in determining the anticipated thermal movement. As a rule of thumb the following thermal movement rates are adopted for aluminium.

Anticipated thermal movement in aluminium

Finish	Approx. temp attained	Movement per metre length (mm)
Stucco/mill	40° - 50°C	1.0
Light colour	40° - 50°C	1.0
Dark colour	70° - 80°C	1.5

It is recommended that on roof areas with sheet lengths exceeding 40 metres the Kalzip reinforced polyamide E clip is used.

Kalzip E clips

The new Kalzip Reinforced Polyamide Clips (E clip) which connect the Kalzip standing seam sheets direct to a support structure and act as an insulation spacer within a Kalzip insulated system, gives minimal thermal impairment allowing thermal-bridge free roofing and wall cladding constructions to be built and the necessary regulations to be met with ease.

The range of Kalzip E clips is manufactured and reinforced with a galvanised steel core and has been fully tested for structural performance in terms of wind suction attachment and load compression as well as durability.

When reinforced polyamide E clips are used within a Kalzip roof system the in-plane forces (friction forces) at the head of the clip resulting from thermal movement of the Kalzip standing seam sheet are dramatically reduced when compared with extruded aluminium clips.

This more efficient accommodation of thermal movement is particularly relevant when designing the structure, sub-structure and fasteners to accommodate long lengths of standing seam sheets potentially allowing thinner structural material and fewer fasteners to be used.

The Kalzip E clip is the standard recommendation for use on roof areas with effective sheet lengths over 40 metres (length from the fixed point).

Fixed points and clip tolerances

To control thermal movement and avoid creepage of the sheet down-slope, a 'fixed-point' is introduced into the system.

Fixed points are usually installed at the ridge position, thus allowing thermal movement to take place at the eaves position. According to the design there will always be exceptions to this rule, and instances of 'fixed points' occurring at the eaves position or mid-slope are not uncommon.

The design of the fixed point is based on a number of given criteria, such as intensity of snow loading, roof pitch and length, width and weight of sheeting.

By using standard formulae with the above criteria, the in-plane forces can be determined and the correct 'fixed point' can be adopted.

E clip benefits at a glance

- Minimal heat transfer allowing thermal-bridge free roofing and cladding constructions
- Guaranteed to withstand the rigours of UV, live and dead loads, thermal cycling etc
- Complies with the requirement of National, European and International energy conservation regulations and standards
- Safe load transmission from the Kalzip standing seam sheeting to the structure or sub-structure
- Excellent properties in the accommodation of thermal movement, which is particularly important where very long sheet lengths are used
- Quickly and simply installed using a variety SFS intec fasteners

Project: Likeng Power Station, China
Architect: Design & Research Institute of
Wuhan Iron and Steel Group



U-values (W/m²K)

Kalzip 50/429, TR35/215 liner, TK15 thermal barrier pad

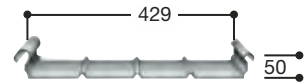

$\lambda_{90/90}$ value (W/mK)	X (mm)	Aluminium clip	Unbridged U-value	Purlin centres (m)									
				1.0	1.2	1.4	1.6	1.8	2.0	2.2	2.4	2.6	2.8
0.040	180	190	0.22	0.27	0.26	0.26	0.25	0.25	0.25	0.24	0.24	0.24	0.24
0.037	180	190	0.20	0.25	0.24	0.24	0.23	0.23	0.23	0.22	0.22	0.22	0.22
0.035	180	190	0.19	0.24	0.23	0.23	0.22	0.22	0.21	0.21	0.21	0.21	0.21
0.032	180	190	0.17	0.23	0.22	0.21	0.21	0.20	0.20	0.20	0.19	0.19	0.19

* For other system build ups please contact the Kalzip technical department.

Kalzip with decking using L clips

TK15 thermal barrier pads and thermal conductivities
($\lambda_{90/90}$ - values of 0.040 W/mK to 0.032 W/mK).

U-values (W/m²K)

Kalzip 65/305, structural decking, TK15 thermal barrier pad

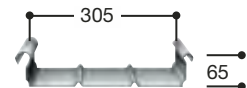

$\lambda_{90/90}$ value (W/mK)	X (mm)	Aluminium clip	Unbridged U-value	Purlin centres (m)									
				1.0	1.2	1.4	1.6	1.8	2.0	2.2	2.4	2.6	2.8
0.040	200	190	0.19	0.28	0.26	0.25	0.24	0.24	0.23	0.23	0.23	0.22	0.22
0.037	200	190	0.19	0.26	0.25	0.24	0.23	0.22	0.22	0.22	0.21	0.21	0.21
	160	150	0.22	0.30	0.28	0.27	0.27	0.26	0.25	0.25	0.25	0.25	0.24
0.035	200	190	0.17	0.25	0.24	0.23	0.22	0.21	0.21	0.21	0.20	0.20	0.20
	160	150	0.21	0.29	0.27	0.26	0.25	0.25	0.24	0.24	0.24	0.23	0.23
	150	140	0.23	0.30	0.28	0.27	0.26	0.26	0.25	0.25	0.25	0.25	0.24
0.032	200	190	0.16	0.24	0.22	0.21	0.21	0.20	0.20	0.19	0.19	0.19	0.18
	160	150	0.19	0.27	0.26	0.24	0.24	0.23	0.22	0.22	0.22	0.22	0.22
	150	140	0.21	0.28	0.26	0.25	0.25	0.24	0.23	0.23	0.23	0.23	0.23
	140	130	0.22	0.29	0.28	0.27	0.26	0.25	0.25	0.24	0.24	0.24	0.24

U-values (W/m²K)

Kalzip 65/400, structural decking, TK15 thermal barrier pad

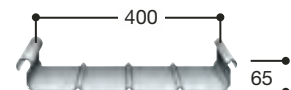

$\lambda_{90/90}$ value (W/mK)	X (mm)	Aluminium clip	Unbridged U-value	Purlin centres (m)									
				1.0	1.2	1.4	1.6	1.8	2.0	2.2	2.4	2.6	2.8
0.040	200	190	0.19	0.26	0.25	0.24	0.23	0.23	0.22	0.22	0.22	0.22	0.22
0.037	200	190	0.18	0.24	0.23	0.23	0.23	0.21	0.21	0.21	0.20	0.20	0.20
	160	150	0.22	0.28	0.27	0.26	0.25	0.25	0.25	0.24	0.24	0.24	0.24
	150	140	0.24	0.29	0.28	0.27	0.26	0.26	0.26	0.26	0.25	0.25	0.25
0.035	200	190	0.17	0.23	0.22	0.21	0.21	0.20	0.20	0.20	0.20	0.19	0.19
	160	150	0.21	0.27	0.26	0.25	0.24	0.24	0.23	0.23	0.23	0.23	0.23
	150	140	0.23	0.28	0.27	0.26	0.25	0.25	0.25	0.24	0.24	0.24	0.24
0.032	200	190	0.16	0.22	0.21	0.20	0.19	0.19	0.19	0.18	0.18	0.18	0.18
	160	150	0.19	0.25	0.24	0.23	0.22	0.22	0.22	0.21	0.21	0.21	0.21
	150	140	0.21	0.26	0.25	0.24	0.23	0.23	0.23	0.22	0.22	0.22	0.22
	140	130	0.22	0.27	0.26	0.25	0.25	0.24	0.24	0.24	0.24	0.24	0.24
	130	120	0.24	0.29	0.28	0.27	0.26	0.26	0.26	0.26	0.25	0.25	0.25

Notes:

Figures in red denote the values established, are not compliant with ADL2.

All U-value calculations are affected by clip frequencies, sheet lengths, insulation types and actual purlin positions. The information contained in this document is for guidance only, for accurate calculations please refer to the Kalzip technical department.

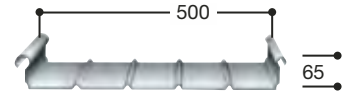

U-values (W/m²K)

Kalzip 65/500, structural decking, TK15 thermal barrier pad

$\lambda_{90/90}$ value (W/mK)	X (mm)	Aluminium clip	Unbridged U-value	Purlin centres (m)									
				1.0	1.2	1.4	1.6	1.8	2.0	2.2	2.4	2.6	2.8
0.040	200	190	0.19	0.24	0.23	0.23	0.22	0.22	0.22	0.22	0.21	0.21	0.21
0.037	200	190	0.18	0.23	0.22	0.21	0.21	0.21	0.20	0.20	0.20	0.20	0.20
	160	150	0.22	0.26	0.26	0.25	0.25	0.24	0.24	0.24	0.24	0.24	0.24
0.035	150	140	0.24	0.28	0.27	0.26	0.26	0.26	0.25	0.25	0.25	0.25	0.25
	200	190	0.17	0.22	0.21	0.20	0.20	0.20	0.19	0.19	0.19	0.19	0.19
0.032	160	150	0.21	0.25	0.24	0.24	0.23	0.23	0.23	0.23	0.23	0.23	0.22
	150	140	0.23	0.26	0.25	0.25	0.25	0.24	0.24	0.24	0.24	0.24	0.24
0.032	200	190	0.16	0.20	0.20	0.19	0.19	0.18	0.18	0.18	0.18	0.17	0.17
	160	150	0.19	0.24	0.23	0.22	0.22	0.21	0.21	0.21	0.21	0.21	0.21
0.032	150	140	0.21	0.24	0.23	0.23	0.23	0.22	0.22	0.22	0.22	0.22	0.22
	140	130	0.22	0.26	0.25	0.24	0.24	0.24	0.24	0.24	0.23	0.23	0.23
0.032	130	120	0.24	0.28	0.27	0.26	0.26	0.26	0.25	0.25	0.25	0.25	0.25

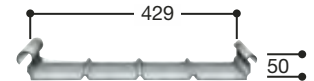

U-values (W/m²K)

Kalzip 50/429, structural decking, TK15 thermal barrier pad

$\lambda_{90/90}$ value (W/mK)	X (mm)	Aluminium clip	Unbridged U-value	Purlin centres (m)									
				1.0	1.2	1.4	1.6	1.8	2.0	2.2	2.4	2.6	2.8
0.040	215	190	0.18	0.24	0.23	0.22	0.22	0.21	0.21	0.21	0.20	0.20	0.20
	175	150	0.22	0.28	0.26	0.26	0.25	0.25	0.25	0.24	0.24	0.24	0.24
0.037	215	190	0.17	0.23	0.22	0.21	0.20	0.20	0.20	0.19	0.19	0.19	0.19
	175	150	0.21	0.26	0.25	0.24	0.24	0.23	0.23	0.23	0.23	0.22	0.22
0.035	165	140	0.22	0.27	0.26	0.25	0.24	0.24	0.24	0.24	0.24	0.23	0.23
	155	130	0.23	0.28	0.27	0.26	0.25	0.25	0.25	0.25	0.25	0.25	0.24
0.032	215	190	0.16	0.22	0.21	0.20	0.19	0.19	0.19	0.18	0.18	0.18	0.18
	175	150	0.19	0.25	0.24	0.23	0.23	0.22	0.22	0.22	0.21	0.21	0.21
0.032	165	140	0.21	0.26	0.25	0.24	0.23	0.23	0.23	0.23	0.22	0.22	0.22
	155	130	0.22	0.27	0.26	0.25	0.24	0.24	0.24	0.24	0.23	0.23	0.23
0.032	145	120	0.23	0.28	0.27	0.26	0.26	0.25	0.25	0.25	0.25	0.25	0.25
	215	190	0.15	0.20	0.19	0.19	0.18	0.18	0.17	0.17	0.17	0.17	0.17
0.032	175	150	0.18	0.23	0.22	0.21	0.21	0.21	0.20	0.20	0.20	0.20	0.20
	165	140	0.19	0.24	0.23	0.22	0.22	0.21	0.21	0.21	0.21	0.21	0.20
0.032	155	130	0.20	0.25	0.24	0.23	0.22	0.22	0.22	0.22	0.22	0.22	0.21
	145	120	0.21	0.26	0.25	0.24	0.24	0.23	0.23	0.23	0.23	0.23	0.23
0.032	135	110	0.23	0.28	0.27	0.26	0.25	0.25	0.25	0.25	0.24	0.24	0.24

Notes:

Figures in red denote the values established, are not compliant with ADL2.

All U-value calculations are affected by clip frequencies, sheet lengths, insulation types and actual purlin positions. The information contained in this document is for guidance only, for accurate calculations please refer to the Kalzip technical department.

Kalzip with liner using E clips

The use of E clips means that the cover width of the Kalzip sheet has no effect on the overall system performance.

E180 clips and thermal conductivities
($\lambda_{90/90}$ - values of 0.040 W/mK to 0.032 W/mK).

U-values (W/m²K)

Kalzip liner roof system with E180 clips

$\lambda_{90/90}$ value (W/mK)	Kalzip 65/400 with TR35/200	Kalzip 65/305 with TR30/152 Kalzip 65/500 with TR30/167	Kalzip 50/429 with TR35/215	Kalzip 50/333 with TR30/167
	145mm thick	150mm thick	160mm thick	165mm thick
0.040	0.27	0.26	0.24	0.23
0.037	0.25	0.24	0.22	0.22
0.035	0.23	0.23	0.21	0.20
0.032	0.21	0.21	0.19	0.19

For information on U-values with Kalzip liner using E clips and spacer please contact the Kalzip technical department.

Kalzip with decking using E clips

Various E clips and thermal conductivities
($\lambda_{90/90}$ - values of 0.040 W/mK to 0.032 W/mK).

U-values (W/m²K)

Kalzip deck roof system with E clips

$\lambda_{90/90}$ (W/mK)	value Kalzip 65	E140 Clip Kalzip 50	Kalzip 65	E160 Clip Kalzip 50	Kalzip 65	E180 Clip Kalzip 50
	140mm thick	155mm thick	160mm thick	175mm thick	180mm thick	195mm thick
0.040	0.27	0.25	0.24	0.22	0.22	0.20
0.037	0.25	0.23	0.22	0.21	0.20	0.18
0.035	0.24	0.22	0.21	0.19	0.19	0.18
0.032	0.22	0.20	0.19	0.18	0.17	0.16

For information on U-values with Kalzip decking using E clips and spacer please contact the Kalzip technical department.

Notes:

Figures in red denote the values established, are not compliant with ADL2.

All U-value calculations are affected by clip frequencies, sheet lengths, insulation types and actual purlin positions. The information contained in this document is for guidance only, for accurate calculations please refer to the Kalzip technical department.

Structural Load span details

Types of span

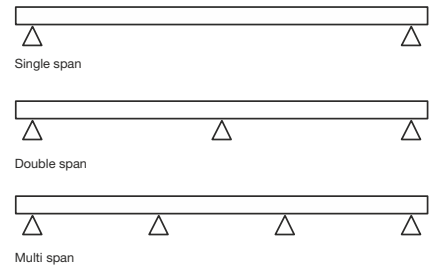

Aluminium Kalzip 65/305, 65/400 and 65/500 using L clips

The following tables give the allowable loading of various Kalzip 65 profiles with Kalzip extruded aluminium clips. All values are for multiple span conditions and are given in kN/m².

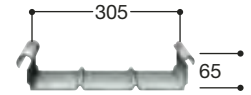

Kalzip 65/305 with aluminium clips

Gauge (mm)	Span (m)									
	1.0	1.2	1.4	1.6	1.8	2.0	2.2	2.4	2.6	2.8
Wind suction load case (maximum deflection = span/90) - maximum unfactored load (kN/m²)										
0.9	6.728	5.611	4.813	4.185	3.386	2.798	2.351	2.005	1.730	1.495
1.0	8.606	7.176	6.155	5.389	4.344	3.576	2.996	2.548	2.194	1.910
1.2	10.032	8.365	7.175	6.282	5.588	4.667	3.885	3.287	2.817	2.442
Snow load case (maximum deflection = span/200) - maximum unfactored load (kN/m²)										
0.9	7.024	5.848	5.007	4.377	3.887	3.232	2.666	2.098	1.642	1.307
1.0	7.020	5.844	5.004	4.374	3.884	3.492	3.037	2.330	1.824	1.452
1.2	7.013	5.837	4.996	4.366	3.876	3.484	3.163	2.798	2.190	1.743

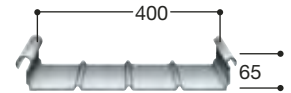

Kalzip 65/400 with aluminium clips

Gauge (mm)	Span (m)									
	1.0	1.2	1.4	1.6	1.8	2.0	2.2	2.4	2.6	2.8
Wind suction load case (maximum deflection = span/90) - maximum unfactored load (kN/m²)										
0.9	5.443	4.539	3.894	3.410	2.878	2.380	2.002	1.709	1.476	1.285
1.0	6.956	5.801	4.976	5.833	5.108	4.544	3.996	3.329	2.817	2.415
1.2	8.155	6.801	5.833	5.108	4.544	3.996	3.329	2.817	2.415	2.095
Snow load case (maximum deflection = span/200) - maximum unfactored load (kN/m²)										
0.9	5.350	4.453	3.813	3.332	2.959	2.660	2.233	1.712	1.339	1.065
1.0	5.347	4.450	3.809	3.329	2.955	2.656	2.412	1.902	1.488	1.183
1.2	5.340	4.443	3.802	3.322	2.948	2.649	2.405	2.201	1.786	1.420

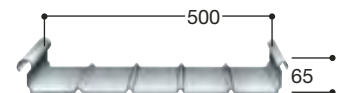

Kalzip 65/500 with aluminium clips

Gauge (mm)	Span (m)									
	1.0	1.2	1.4	1.6	1.8	2.0	2.2	2.4	2.6	2.8
Wind suction load case (maximum deflection = span/90) - maximum unfactored load (kN/m²)										
0.9	4.106	3.425	2.939	2.574	2.291	1.933	1.629	1.392	1.204	1.052
1.0	5.245	4.375	3.753	3.287	2.924	2.493	2.093	1.783	1.538	1.341
1.2	6.164	5.142	4.411	3.863	3.437	3.096	2.736	2.317	1.988	1.725
Snow load case (maximum deflection = span/200) - maximum unfactored load (kN/m²)										
0.9	4.276	3.558	3.046	2.662	2.363	2.123	1.791	1.435	1.122	0.891
1.0	4.273	3.555	3.043	2.658	2.359	2.120	1.925	1.597	1.248	0.992
1.2	4.266	3.549	3.036	2.652	2.353	2.114	1.918	1.755	1.495	1.188

Aluminium Kalzip 50/333 and 50/429 using L clips

The following tables give the allowable loading of various Kalzip 50 profiles with Kalzip extruded aluminium clips. All values are for multiple span conditions and are given in kN/m².

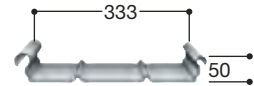

Kalzip 50/333 with aluminium clips

Gauge (mm)	Span (m)									
	1.0	1.2	1.4	1.6	1.8	2.0	2.2	2.4	2.6	2.8
Wind suction load case (maximum deflection = span/90) – maximum unfactored load (kN/m²)										
0.9	5.004	4.173	3.579	2.964	2.391	1.970	1.653	1.407	1.213	1.057
1.0	6.384	5.323	4.566	3.997	3.318	2.714	2.262	1.810	1.432	1.154
1.2	6.913	5.765	4.944	4.329	3.568	2.984	2.535	2.182	1.898	1.634
Snow load case (maximum deflection = span/200) – maximum unfactored load (kN/m²)										
0.9	6.433	5.003	3.747	2.909	2.322	1.858	1.387	1.060	0.827	0.655
1.0	6.430	5.353	4.410	3.430	2.742	2.061	1.539	1.176	0.917	0.727
1.2	6.423	5.346	4.576	3.999	3.172	2.474	1.847	1.412	1.101	0.872

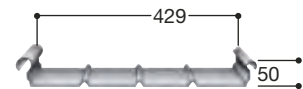

Kalzip 50/429 with aluminium clips

Gauge (mm)	Span (m)									
	1.0	1.2	1.4	1.6	1.8	2.0	2.2	2.4	2.6	2.8
Wind suction load case (maximum deflection = span/90) – maximum unfactored load (kN/m²)										
0.9	3.887	3.242	2.781	2.429	1.960	1.616	1.356	1.155	0.996	-
1.0	4.959	4.135	3.547	3.106	2.713	2.220	1.850	1.542	1.220	-
1.2	5.370	4.479	3.842	3.364	2.923	2.446	2.078	1.789	1.557	1.369
Snow load case (maximum deflection = span/200) – maximum unfactored load (kN/m²)										
0.9	4.989	4.152	3.487	2.713	2.103	1.524	1.137	0.868	0.676	-
1.0	4.985	4.149	3.552	3.104	2.329	1.688	1.259	0.962	0.749	-
1.2	4.979	4.143	3.545	3.097	2.749	2.023	1.509	1.152	0.897	0.709

Notes:

- All loads are in kN/m² and are assumed to be applied uniformly
- The self-weight of the Kalzip sheeting has been taken into account in the above loadings
- The following load factors have been taken into account in the design capacity of the sheeting:
 - Dead load = 1.4
 - Dead load (restraining wind uplift) = 1.0
 - Snow load = 1.6
 - Attachment resisting wind uplift = 2.0
 - Wind load = 1.4
- All spans are assumed to be equal or within 15% of largest span
- The above snow loadings are applicable for Kalzip sheets with aluminium clips type 190 or below
- For loading conditions outside of the above please contact the Kalzip technical department

All U-value calculations are affected by clip frequencies, sheet lengths, insulation types and actual purlin positions. The information contained in this document is for guidance only, for accurate calculations please refer to the Kalzip technical department.

Aluminium Kalzip 65/305, 65/400 and 65/500 using E clips

The following tables give the allowable loading of various aluminium Kalzip 65 profiles with Kalzip reinforced polyamide E-clips. All values are for multiple span conditions and are given in kN/m².

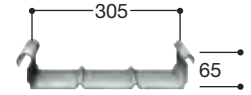

Kalzip 65/305 with E-clips

Gauge (mm)	Span (m)									
	1.0	1.2	1.4	1.6	1.8	2.0	2.2	2.4	2.6	2.8
Wind suction load case (maximum deflection = span/90) – maximum unfactored load (kN/m²)										
0.9	4.174	3.482	2.987	2.616	2.327	2.097	1.908	1.750	1.617	1.495
1.0	5.323	4.439	3.808	3.335	2.966	2.672	2.431	2.230	2.060	1.910
1.2	7.118	5.936	5.091	4.458	3.966	3.572	3.249	2.981	2.753	2.442
Snow load case (maximum deflection = span/200) – maximum unfactored load (kN/m²)										
0.9	5.916	4.924	4.216	3.865	3.272	2.941	2.666	2.235	1.899	1.633
1.0	5.912	4.920	4.212	3.681	3.268	2.937	2.667	2.442	2.212	1.907
1.2	5.904	4.913	4.205	3.674	3.260	2.930	2.660	2.434	2.244	2.080

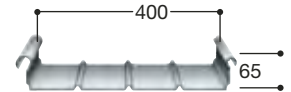

Kalzip 65/400 with E-clips

Gauge (mm)	Span (m)									
	1.0	1.2	1.4	1.6	1.8	2.0	2.2	2.4	2.6	2.8
Wind suction load case (maximum deflection = span/90) – maximum unfactored load (kN/m²)										
0.9	3.186	2.658	2.281	1.998	1.778	1.602	1.458	1.338	1.236	1.149
1.0	4.062	3.388	2.907	2.546	2.265	2.041	1.857	1.704	1.574	1.463
1.2	5.431	4.530	3.886	3.403	3.028	2.727	2.482	2.277	2.103	1.955
Snow load case (maximum deflection = span/200) – maximum unfactored load (kN/m²)										
0.9	4.505	3.749	3.209	2.804	2.489	2.237	2.031	1.859	1.595	1.371
1.0	4.502	3.746	3.206	2.801	2.486	2.234	2.028	1.856	1.710	1.586
1.2	4.495	3.739	3.199	2.794	2.479	2.227	2.021	1.849	1.703	1.579

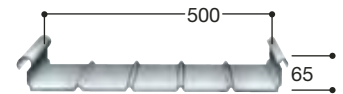

Kalzip 65/500 with E-clips

Gauge (mm)	Span (m)									
	1.0	1.2	1.4	1.6	1.8	2.0	2.2	2.4	2.6	2.8
Wind suction load case (maximum deflection = span/90) – maximum unfactored load (kN/m²)										
0.9	2.551	2.129	1.827	1.601	1.425	1.284	1.169	1.073	0.991	-
1.0	3.252	2.713	2.328	2.040	1.815	1.635	1.488	1.366	1.262	-
1.2	4.348	3.627	3.112	2.726	2.426	2.185	1.989	1.825	1.686	-
Snow load case (maximum deflection = span/200) – maximum unfactored load (kN/m²)										
0.9	3.600	2.995	2.563	2.239	1.987	1.785	1.620	1.483	1.274	1.094
1.0	3.597	2.992	2.560	2.236	1.984	1.782	1.617	1.480	1.363	1.264
1.2	3.590	2.985	2.553	2.229	1.977	1.776	1.611	1.473	1.357	1.257

Aluminium Kalzip 50/333 and 50/429 with E clips

The following tables give the allowable loading of various aluminium Kalzip 50 profiles with Kalzip reinforced polyamide E clips. All values are for multiple span conditions and are given in kN/m².

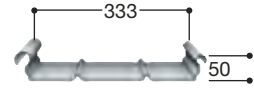

Kalzip 50/333 with E-clips

Gauge (mm)	Span (m)									
	1.0	1.2	1.4	1.6	1.8	2.0	2.2	2.4	2.6	2.8
Wind suction load case (maximum deflection = span/90) – maximum unfactored load (kN/m²)										
0.9	3.430	2.861	2.455	2.150	1.913	1.723	1.568	1.407	1.213	1.057
1.0	4.416	3.683	3.160	2.797	2.462	2.218	2.018	1.810	1.432	1.154
1.2	6.519	5.437	4.663	4.083	3.568	2.984	2.535	2.182	1.898	1.634
Snow load case (maximum deflection = span/200) – maximum unfactored load (kN/m²)										
0.9	4.672	3.888	3.328	2.908	2.322	1.895	1.571	1.315	1.116	0.958
1.0	4.668	3.885	3.325	2.905	2.578	2.240	1.863	1.561	1.325	1.067
1.2	4.662	3.878	3.318	2.898	2.572	2.310	2.097	1.766	1.499	1.281

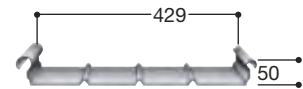

Kalzip 50/429 with E clips

Gauge (mm)	Span (m)									
	1.0	1.2	1.4	1.6	1.8	2.0	2.2	2.4	2.6	2.8
Wind suction load case (maximum deflection = span/90) – maximum unfactored load (kN/m²)										
0.9	2.665	2.224	1.908	1.672	1.488	1.341	1.220	1.120	0.996	-
1.0	3.431	2.862	2.456	2.151	1.914	1.724	1.569	1.440	1.220	-
1.2	5.064	4.224	3.624	3.173	2.823	2.446	2.078	1.789	1.557	1.369
Snow load case (maximum deflection = span/200) – maximum unfactored load (kN/m²)										
0.9	3.621	3.013	2.578	2.252	1.999	1.773	1.475	1.245	0.991	0.787
1.0	3.618	3.010	2.575	2.249	1.996	1.793	1.627	1.406	1.098	0.872
1.2	3.612	3.003	2.569	2.243	1.989	1.787	1.621	1.483	1.316	1.045

Notes:

- All loads are in kN/m² and are assumed to be applied uniformly
- The self-weight of the Kalzip sheeting has been taken into account in the above loadings
- The following load factors have been taken into account in the design capacity of the sheeting:
 - Dead load = 1.4
 - Dead load (restraining wind uplift) = 1.0
 - Snow load = 1.6
 - Attachment resisting wind uplift = 2.0
 - Wind load = 1.4
- All spans are assumed to be equal or within 15% of largest span
- The above snow loadings are applicable for Kalzip sheets with reinforced polyamide E clips
- For loading conditions outside of the above please contact the Kalzip technical department

All U-value calculations are affected by clip frequencies, sheet lengths, insulation types and actual purlin positions. The information contained in this document is for guidance only, for accurate calculations please refer to the Kalzip technical department.

Material characteristics

Fire performance

Approved Document B (2000) of the Building Regulations describes the requirements of fire safety as:

- B1 – Means of warnings and escape
- B2 – Internal fire spread linings
- B3 – Internal fire spread (structure)
- B4 – External fire spread
- B5 – Access and facilities for the fire service

Roofs are primarily covered by part B4 (section 15) which limits the use of materials near a boundary against the spread of flame over the roof (Distances less than 6 metre materials must be AA, AB or AC designation).

External spread of flame

The Kalzip sheets have a notional AA designation as defined by BS 476 Part 3:1975 and achieve a European fire classification of A1 when tested to BS EN ISO 1182:2002, provided the insulation installed has a non-combustible classification when tested in accordance with BS 476: Part 4:1970 (1984).

Internal spread of flame

Aluminium and steel sheeting when used as an internal lining will be classified as Class 0 which is the highest performance classification as per Approved Document B (2000).

Approved Document B (2000) generally does not require roofs to have a fire resistance but recognises that there may be some circumstances where roofs or part of roofs may require a degree of fire resistance, such as when any part forms an escape route or performs the function of a floor.

For specific information regarding to the fire resistance performance of the Kalzip roofing and cladding systems please refer to the Kalzip Technical Department.

LPC Requirement

The Loss Prevention Council requirement contained in Appendix C of LPS 1181: Part 1: 2003 is that the insulating core of a built up cladding system should be classified as non-combustible, Euroclass A1 or A2 or of limited combustibility.

Unfaced and faced (with glass tissue) glass and rock mineral fibre Kalzip Insulation products are non-combustible to BS 476: Part 4, Class O to Building Regulation requirements and are Euroclass A1 when classified in accordance with BS EN 13501-1: 2002.

Durability

Kalzip aluminium roofing and cladding systems have been used extensively in construction over the past 40 years and they continue to be the preferred choice for highly demanding environmental conditions, such as industrial, city centre, marine and airport locations. One of the unique features of Kalzip is the use of highly durable clad alloys for the additional protection of the core material. This outer cladding or plating gives Kalzip outstanding long term resistance to corrosion.

Testing of the material's capabilities has been ongoing throughout Kalzip's history. Most notably, in 1997, The Federal Institute for Material Research and Testing (BAM) in Germany published a test report, BAM-Ref: 1.4/11416 N1 setting out the results of test carried out in 1993 on a series of Kalzip installations, including on the roof canopy of the Congress Hall in Nuremberg. Here Kalzip 305 profile was installed in 1968 and at the time of testing was approximately 25 years old.

Compatibility with other materials

Stucco-finished uncoated aluminium sheets must not come into contact with materials listed below. Where problems of incompatibility are likely to occur, barriers (e.g. paints, bimetallic separation tapes or pads, appropriate to the materials and environment) should be incorporated.

Material	Environment		
	Rural	Industrial	Marine
Zinc	safe	safe	safe
Stainless steel	safe	safe	safe*
Lead	safe	safe	unsafe
Uncoated steel	unsafe	unsafe	unsafe
Copper	unsafe	unsafe	unsafe
Timber treated with fire retardant or preserved with copper or fluoride compounds	unsafe	unsafe	unsafe
Concrete, mortar or alkali-bearing materials	unsafe	unsafe	unsafe

*This applies only for fixing screws and rivets made from stainless steel, other stainless steel elements must be protected.

Lightning conduction and protective screening of buildings

The Kalzip system offers safe and effective protection against lightning strikes and their electro-magnetic effect on both plant and equipment, by acting as:

- A lightning arrest or conducting device to prevent lightning strikes affecting the structure
- A protective screen to counter the electromagnetic effect of lightning strikes

When installing Kalzip roof or wall cladding systems there is generally no need for dedicated or additional lightning protection devices. The calculated probability of structurally damaging lightning strikes is once in every 500 years. Such a strike hitting a Kalzip clad building would cause, at worst, no more than a small hole in one of the sheet seams.

Kalzip as a conductor of lightning

Kalzip aluminium profiled sheets can be regarded as natural components of a lightning conducting system, as per the International Standard ENV 61024-1 "Protection of structures against lightning - Part 1: General Principles", because the crimped seams of the sheets give a permanent electric connection.

Technical requirements for lightning conducting devices

- The Kalzip sheets must be conductively connected to earth
- The seams of the Kalzip sheets must be fully zipped to ensure contact
- There must be conductive connection of the roof sheets to:
 - a conductive wall cladding (metal)
 - a steel or aluminium sub-structure
 - any concrete sub-structure must be reinforced

Kalzip as a protective screening

If the complete building envelope consists of aluminium, i.e. Kalzip systems used for both the roof and wall cladding, the envelope will halt and collect the electrical energy from lightning and safely conduct it to earth thereby preventing dangerous voltages from affecting the power supplies. IT networks and electronic control systems connected to the mains power supplies will be safely protected from damage and in most instances there will be no need for additional protective devices.

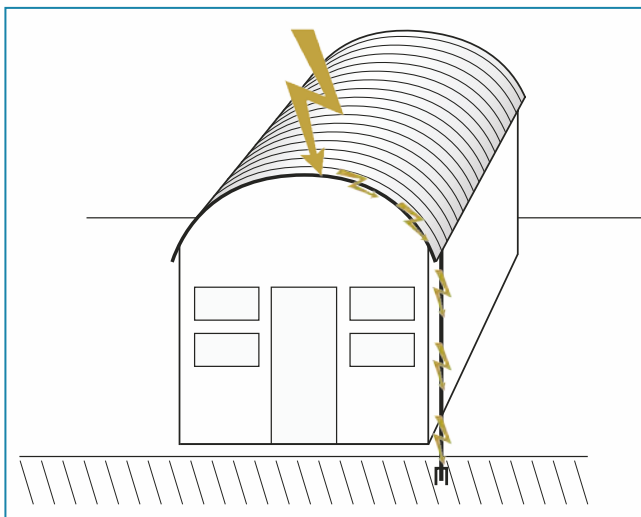

Kalzip as a conductor of lightning

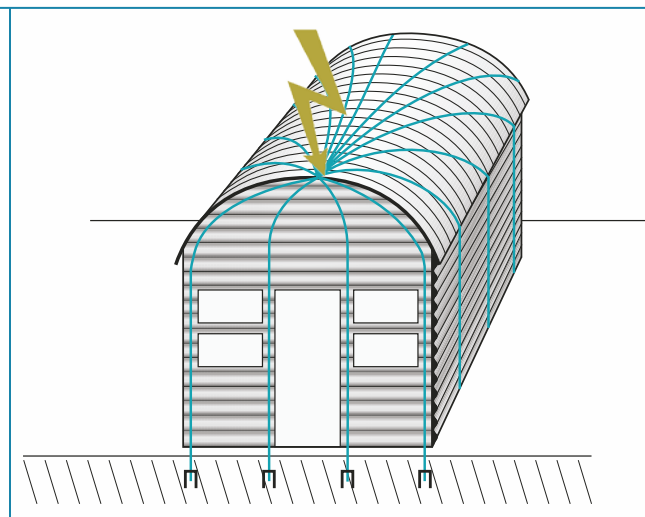

Kalzip as protective screening

On-site requirements

Where site or local access restrictions apply, Kalzip have the equipment, personnel and expertise to manufacture on-site. Mobile roll former machines with integral generators offer a flexible and effective solution. On-site roll-forming can be done at either ground, ground to eaves or eaves levels, and in the case of the latter, the fully-integrated production facility (roughly 6m long) needs to be mounted on scaffolding or a similar type of platform.

It is possible to reposition the mobile roll-former during the manufacturing process, so that the finished sheets are as close as possible to where they will be required.

Appropriate lifting beams can also be supplied to carry the sheets into position.

Kalzip's professional team produces a full operations document, detailing requirements, safe working procedures and risk assessment.

ISO 9001:2008 also applies to site production and all quality tests and samples are undertaken on site in keeping with Kalzip's factory tests.

Requirements for on-site production of Kalzip

- Secure compound to keep coils in during production
- Access to stacker truck capable of lifting 3 tonne coils. Dependant where coils are stored on site.
- Material handlers, recommend one operative every 6 metres.

Ground level production

- Hard ground foundation, capable of accommodating tractor unit and trailer with roll former. Combined weight of 38 tonnes (Approx. size 20 metres long by 5 metres wide).

Eaves level production

- A certified scaffold platform at eaves level capable of accommodating the roll former, generator and 3 tonne coil. Total weight: 15 tonne. (approx. 12 metres long by 6 metres wide)
- A copy of the scaffold certification, prior to the roll former being loaded onto the scaffold.
- A crane to lift the roll former, generator on and off the platform. (First and last day of proposed production run)

- A crane to lift the 3 tonne coils up to the platform during the production run (Intermediate days during production run)

Quality control

- ISO 9001:2008 now applies to all on-site production.
- All quality tests and samples are now undertaken on site in keeping with our factory tests.
- All on-site production has same dimensional quality as factory production.

Site practice and workmanship

On-site support

Support on live projects in both the UK and overseas, is provided by the site services department for approved contractors, specifiers and end users.

Support includes ongoing site inspections, technical advice, site investigations and on-site production surveys.

On-site support is also available for the on-site roll-forming facility.



Benefits at a glance

- No lapping: the on-site production eliminates virtually all requirements for lap joints
- No maintenance
- Reduced transport costs: up to 5000 m² of coil can be delivered on a single trailer, dramatically reducing transport time and costs.
- Reduced handling on-site: aluminium sheets are half the weight of steel, which in turn, reduces the amount of labour required on site.
- Reduced crane requirements: roof sheets can be roll-formed straight onto the roof, reducing the dependency on cranes.
- Flexible manufacturing: any damaged sheets can be replaced immediately.

Technical services and support

Technical support

Using the latest CAD equipment, the Kalzip technical team is fully equipped to meet the specification requirements of the most complex roof designs down to the finest detail.

Trained staff work closely with clients, tailoring specifications to meet individual requirements of the project - including all necessary calculations, assembly instructions and technical advice - ensuring that both specification and delivery requirements are met. Kalzip provide a comprehensive technical advisory and support service to assist architects, designers, specifiers and approved Kalzip installation contractors with building design, product application and site work issues, from design stage through to project completion and beyond.

The Technical Services Department has extensive roofing and cladding expertise and can provide suitable designs and details for any application via the latest CAD equipment. Economical construction solutions for the most complex roof designs can also be provided. With the increasing pace of Kalzip's new product introductions and ability to comply with the improving Building Regulations, additional information to support both the specifier and installer alike are constantly being developed.

More complex shapes and solutions not only mean increased capability within the technical team but also the ability of the

department to communicate necessary knowledge to Kalzip's installer network via its training school and courses. Finally, the Kalzip technical department are constantly supporting the projects in progress through the team of dedicated site supervisors who bring back practical solutions of site issues that can then be integrated into courses to develop and tailor the material providing solutions and preventing repeated difficulties.

Training centre

Kalzip's new state-of-the-art training centre is a purpose-built facility situated next to the company's headquarters in Haydock, St Helens.

Incorporating a 445 sqm workshop and an 87 sqm training room, the facility underpins Kalzip's ongoing investment in training and commitment to best practice, ensuring that Kalzip systems provide optimum performance throughout the lifetime of the building.

Equipped to the highest standards, the centre accommodates up-to-date training techniques covering technical information and practical installation advice on existing and recent introductions to the Kalzip range of products.

Focusing on estimating, designing, installation and general product awareness, participants are encouraged to apply the knowledge they gain in the classroom to practical situations through

specially prepared simulated roof rigs designed to demonstrate the installation of the complete range of products and standard details.

Dedicated full-time training staff provide the following courses throughout the year:

- General Operators Course (CITB approved)
- General Operators Refresher Course (CITB approved)
- Estimators and Designers Course (CITB approved)
- Kalzip Awareness Course

For further information on course details and bookings please contact the Kalzip Training Co-ordinator:
T: +44 (0) 1942 295500
E: training.uk@kalzip.com

The Teamkal Network

Installation of Kalzip roofing and cladding systems is only carried out by trained and approved installers.

The Teamkal Network – the most experienced and highly trained independent installer network in the UK ensures the correct installation of Kalzip products and their system derivatives.





Kalzip around the world

Kalzip international

Changes within the construction industry have led Kalzip to develop a dedicated international team with the commercial and technical experience to support and service customer requirements on a global scale.

A changing industry

An increase in global relationships has taken design and construction to a new level where architects, installation contractors and construction sites can be based in three completely separate countries. Where this occurs the Kalzip international team work closely with their regional colleagues and each of the project specialists to offer their service and support through all stages of design, tender and construction.

Benefitting design teams worldwide

Bringing together a wealth of experience over a range of disciplines, the Kalzip international team ensures that all the

key stages in designing, tendering, securing and delivering the project are addressed. Tailoring specifications precisely to the customer's requirements, Kalzip provides assistance and guidance with calculations, local building standards, climate considerations, logistics, and installation.

All these are complex yet fundamental requirements, and ones that form the basis of the international team in supporting the project from concept to completion. With each project there is a clear direction with established levels of responsibility and focus. Lines of communication are improved and every project is monitored and progressed on all fronts with regional differences and language considerations taken into account.

For further information email: international@kalzip.com

Project: Student Halls of Residence, Osijek, Croatia
Architect: Arvum Teh

An impressive list of international projects stand testament to Kalzip's ability to perform in a wide array of applications and conditions



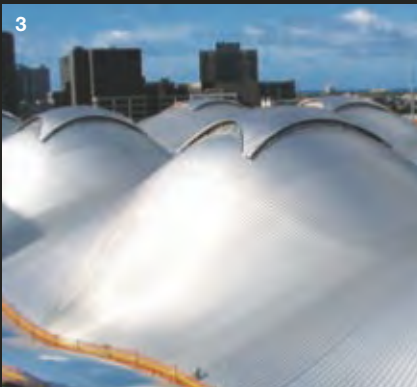

1. Agora Theatre, Lelystad, The Netherlands
2. Science Museum, Valencia, Spain
3. Spencer Street Station, Melbourne, Australia
4. University Federal Credit Union, Texas, USA
5. DELL Call Centre, Montpellier, France
6. Motorway Inn, Quinto Switzerland
7. BMW, Leipzig, Germany
8. Barajas Airport, Madrid, Spain
9. Fashion Centre, Almere The Netherlands
10. Taipei Arena, Taiwan

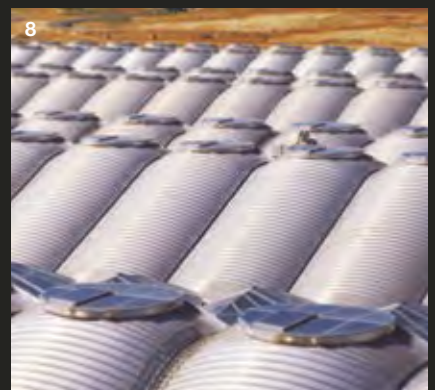



- 11. Millennium Grandstand, Nad Al Sheba Dubai
- 12. Leon van Gelder College, Groningen, The Netherlands
- 13. Würth Offices, Den Bosch, The Netherlands
- 14. Mumbai T1B Domestic Airport, India
- 15. Forshan Lingnan Peral Stadium, China
- 16. Nanjing Olympic Centre, China
- 17. Mapo Waste Incinerator, Seoul, South Korea
- 18. Exhibition Hall 3, Frankfurt, Germany
- 19. AsiaWorld Expo, Hong Kong
- 20. National Grand Theatre, Beijing, China

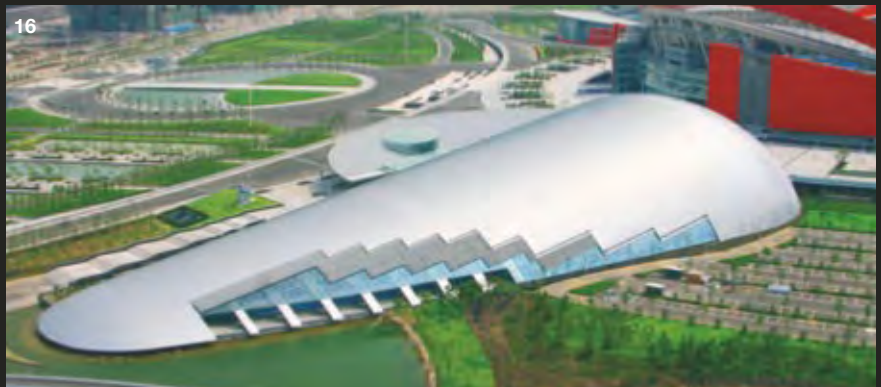

www.kalzip.com

Kalzip is a registered trademark. While care has been taken to ensure that the information contained in this publication is accurate, neither Kalzip GmbH, nor its subsidiaries, accept responsibility or liability for errors or for information which is found to be misleading. Before using products or services supplied or manufactured by Kalzip GmbH, customers should satisfy themselves as to their suitability.

Copyright © 2019
Kalzip GmbH

Kalzip UK

Haydock Lane

Haydock

St Helens

Merseyside WA11 9TY

United Kingdom

T: +44 (0) 1942 295 500

F: +44 (0) 1942 295 508

E: enquiries.uk@kalzip.com

English 01/19