

CW 60

CW 60

R

REYNAERS
aluminium

Edition 11/2010 (based on 089.C52D.00)

CW 60



CW 60

- 1 Internal structure
- 2 External aesthetics
- 3 Fixed elements
- 4 Opening elements
- 5 Junction detail

CW 60-HI

CW 60-HL

CW 60 Structural Clamped (CW 60-SC)

CW 60 Structural Glazing (CW 60-SG)

CW 60



1 Internal structure

Vertical internal structure

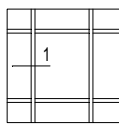

CW 60 - 002

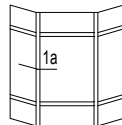

CW 60 - 002

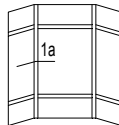

CW 60 - 002

Horizontal internal structure

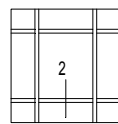

CW 60 - 004

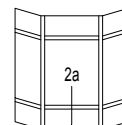

CW 60 - 004

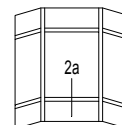

CW 60 - 004

2 External aesthetics

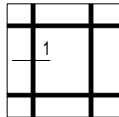

CW 60 - 007

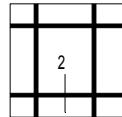

CW 60 - 008

3 Fixed elements

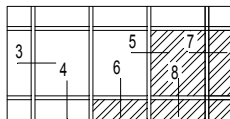

CW 60 - 009

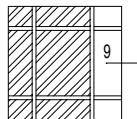

CW 60 - 011

4 Opening elements

Windows

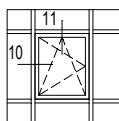

CW 60 - 012

Windows with Hidden Vent

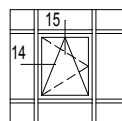

CW 60 - 013

Windows with structural Vent

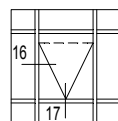

CW 60 - 014

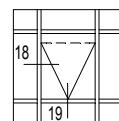

CW 60 - 016

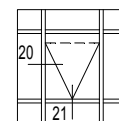

CW 60 - 018

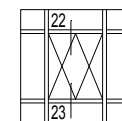

CW 60 - 019

Inward opening doors

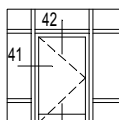

CW 60 - 024

Outward opening doors

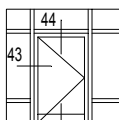

CW 60 - 025

Sliding doors

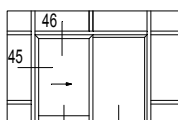

CW 60 - 026

Automatic sliding doors

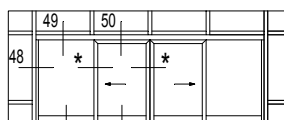

CW 60 - 027

* Other sections : go to corresponding system where the other sections of the opening elements are shown.



5 Junction detail

Angle solutions

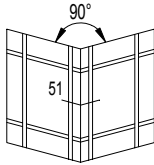

CW 60 - 030

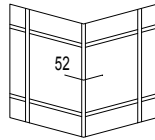

CW 60 - 032

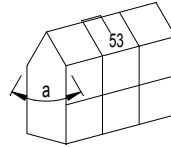

CW 60 - 033

Dilatation

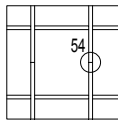

CW 60 - 034

Fixed elements

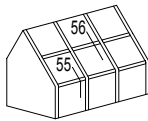

CW 60 - 036

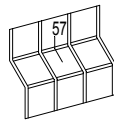

CW 60 - 038

Opening elements

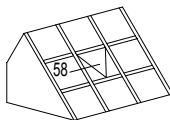

CW 60 - 039

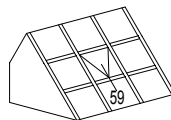

CW 60 - 040

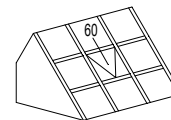

CW 60 - 041

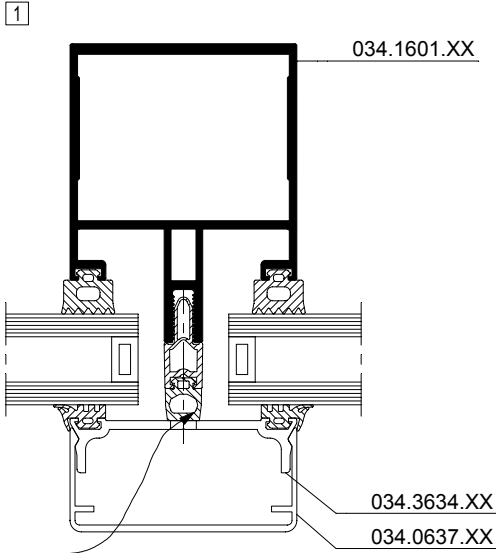
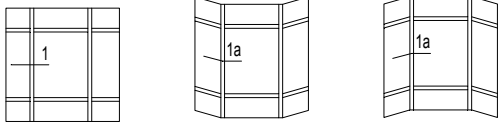

Variant
 Variante
 Variant
 Variante

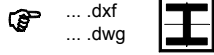

Verticale compartimentering is optioneel
 Compartmentalisation verticale est optionnelle
 Vertical compartmentation is optional
 Vertikale Kompartimentierung ist eine Option

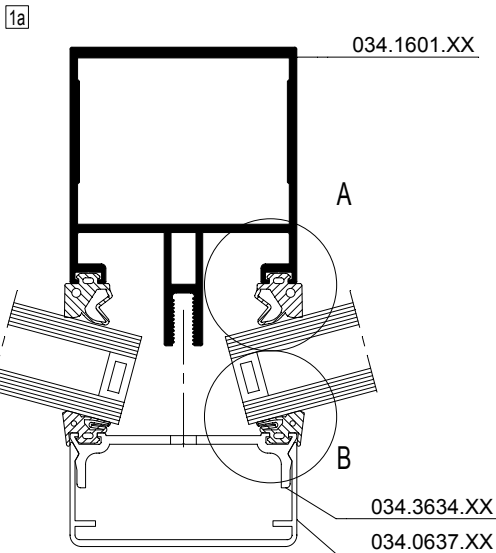

MIN. 150°

MAX. 210°

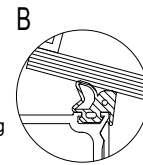
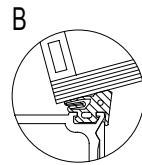
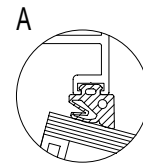
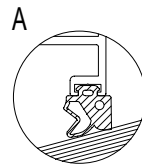

CW60-01a001.dxf
 CW60-01a001.dwg

CW60-01a002.dxf
 CW60-01a002.dwg

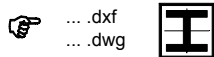

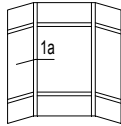
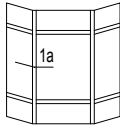
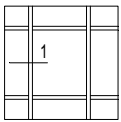

034.1601.XX

$I_x = 44.642 \text{ cm}^4$

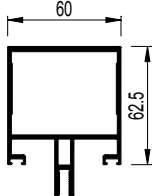

CW60-001001.dxf
 CW60-001001.dwg

034.1602.XX

$I_x = 99.298 \text{ cm}^4$

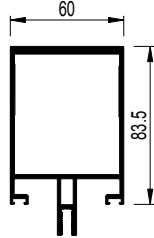

CW60-001002.dxf
 CW60-001002.dwg

034.1604.XX

$I_x = 167.949 \text{ cm}^4$

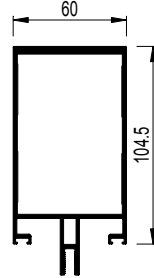

CW60-001003.dxf
 CW60-001003.dwg

034.1605.XX

$I_x = 258.583 \text{ cm}^4$

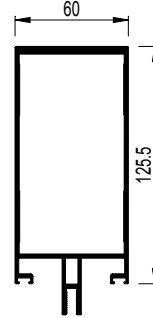

CW60-001004.dxf
 CW60-001004.dwg

034.1606.XX

$I_x = 377.487 \text{ cm}^4$

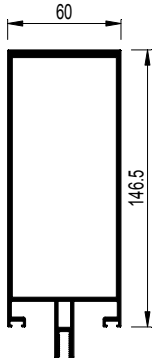

CW60-001005.dxf
 CW60-001005.dwg

034.1607.XX

$I_x = 551.226 \text{ cm}^4$

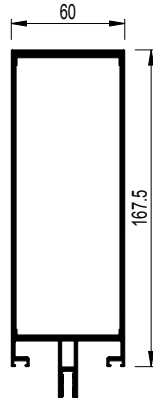

CW60-001006.dxf
 CW60-001006.dwg

034.1608.XX

$I_x = 736.559 \text{ cm}^4$

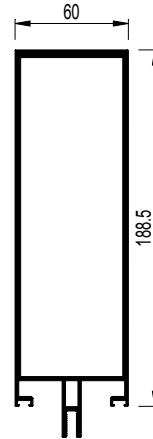

CW60-001007.dxf
 CW60-001007.dwg

034.1609.XX

$I_x = 1014.894 \text{ cm}^4$

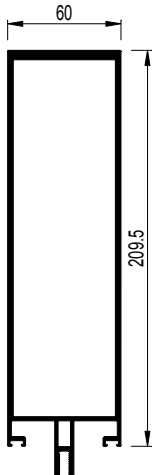

CW60-001008.dxf
 CW60-001008.dwg

034.1610.XX

$I_x = 1504.315 \text{ cm}^4$

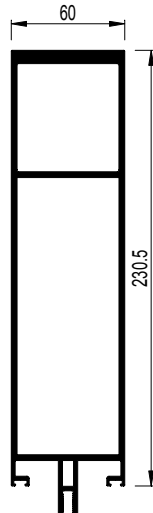

CW60-001009.dxf
 CW60-001009.dwg

034.1611.XX

$I_x = 1914.141 \text{ cm}^4$

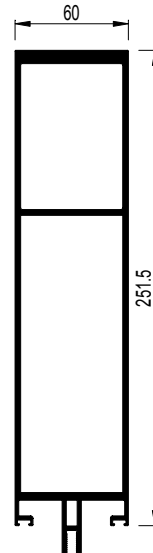

CW60-001010.dxf
 CW60-001010.dwg

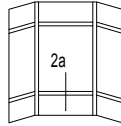
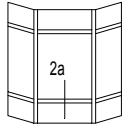
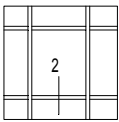

2

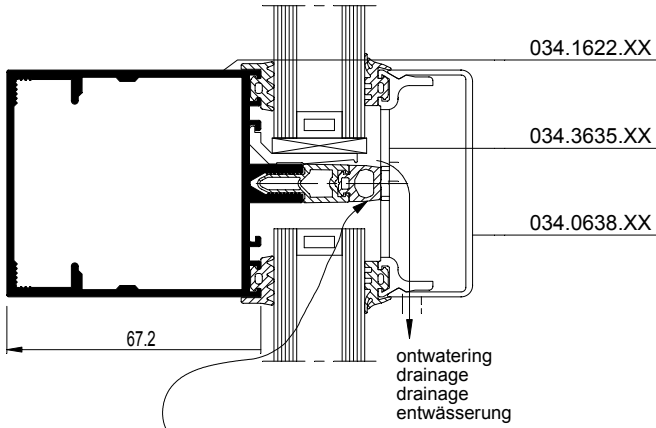

Horizontale compartimentering is verplicht
 Compartimentation horizontale est obligatoire
 Horizontal compartmentalization is obligatory
 Horizontale Kompartimentierung ist verpflichtet

☞ ...dxf
 ☞ ...dwg



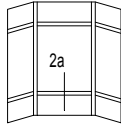
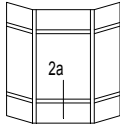
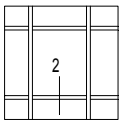

034.1622.XX

$I_x =$	45.472 cm ⁴
$I_y =$	32.822 cm ⁴

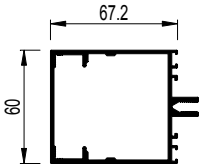

2 CW60-002001.dxf
 CW60-002001.dwg

034.1623.XX

$I_x =$	87.600 cm ⁴
$I_y =$	41.284 cm ⁴

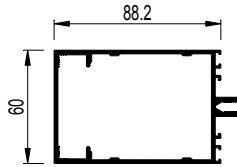

2 CW60-002002.dxf
 CW60-002002.dwg

034.1624.XX

$I_x =$	155.867 cm ⁴
$I_y =$	54.376 cm ⁴

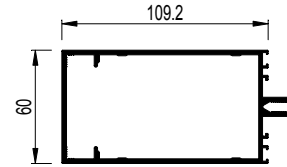

2 CW60-002003.dxf
 CW60-002003.dwg

034.1625.XX

$I_x =$	238.553 cm ⁴
$I_y =$	63.058 cm ⁴

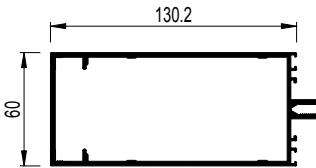

2 CW60-002004.dxf
 CW60-002004.dwg

034.1626.XX

$I_x =$	344.041 cm ⁴
$I_y =$	71.745 cm ⁴

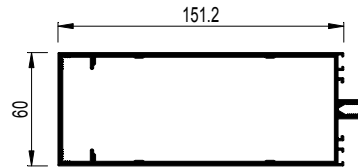

2 CW60-002005.dxf
 CW60-002005.dwg

034.1627.XX

$I_x =$	474.462 cm ⁴
$I_y =$	80.427 cm ⁴

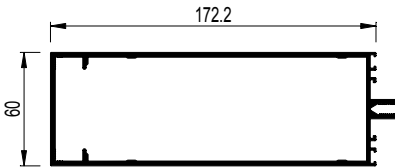

2 CW60-002006.dxf
 CW60-002006.dwg

034.1628.XX

$I_x =$	632.340 cm ⁴
$I_y =$	89.111 cm ⁴

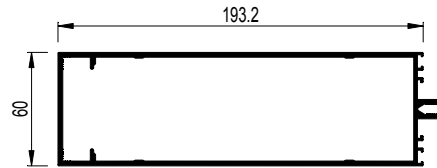

2 CW60-002007.dxf
 CW60-002007.dwg

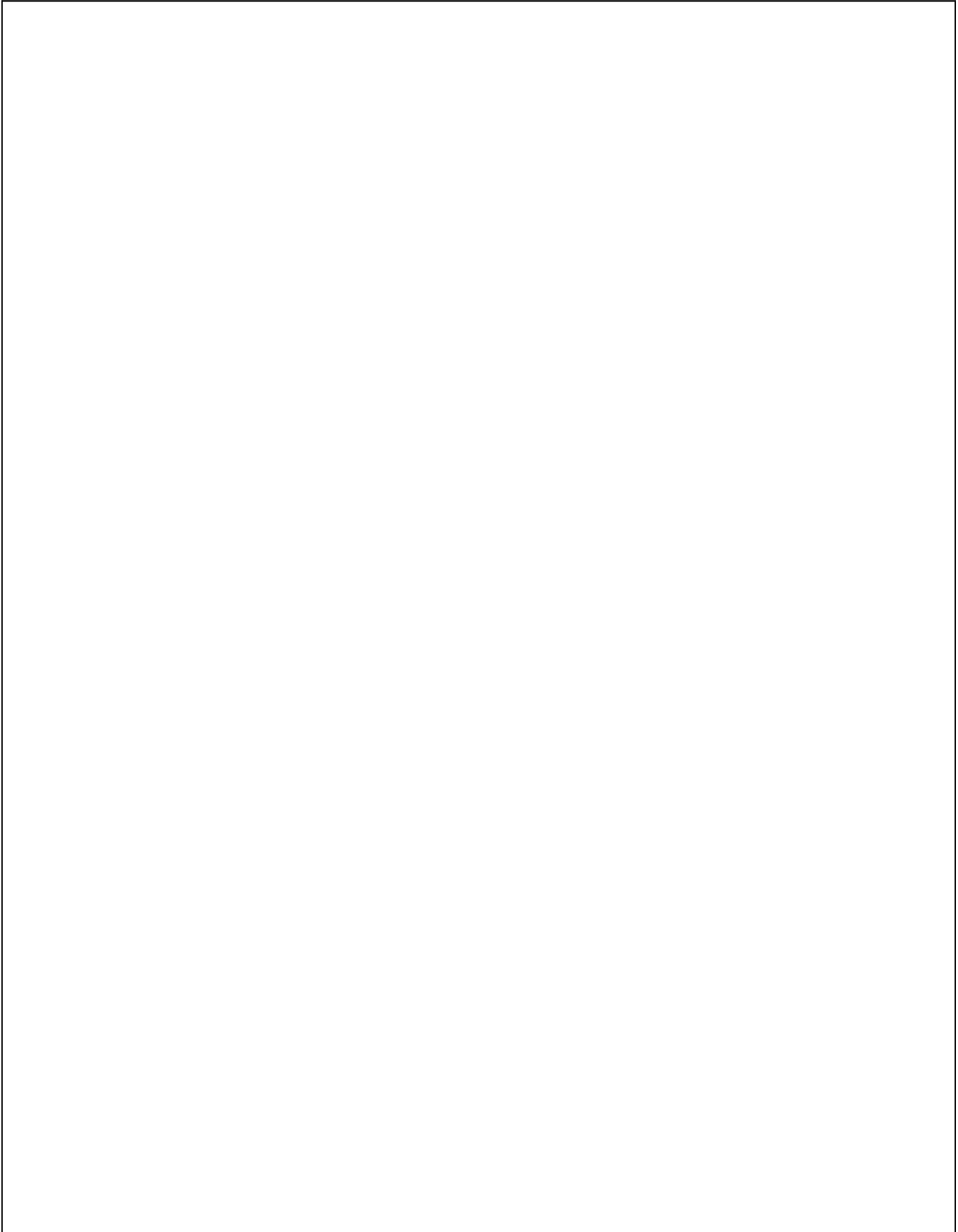

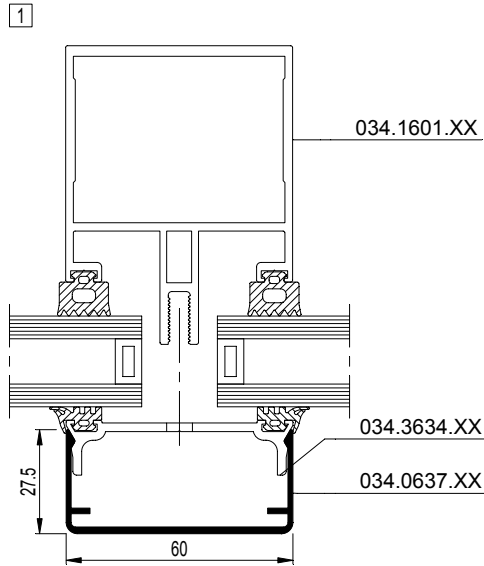
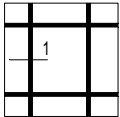

CW60-001013.dxf
 CW60-001013.dwg

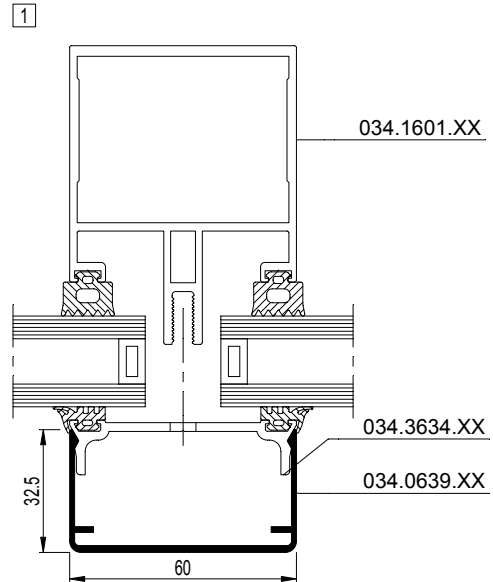

CW60-001014.dxf
 CW60-001014.dwg

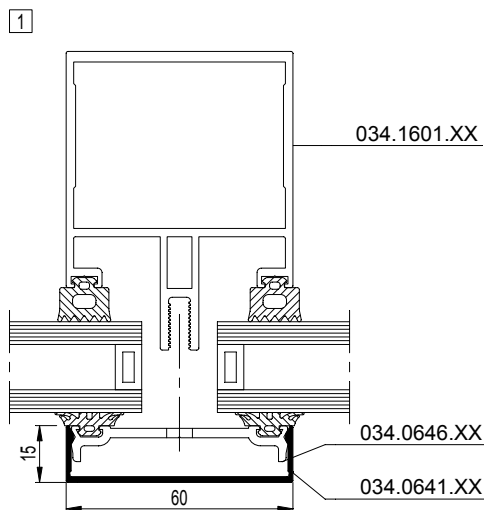

CW60-001015.dxf
 CW60-001015.dwg

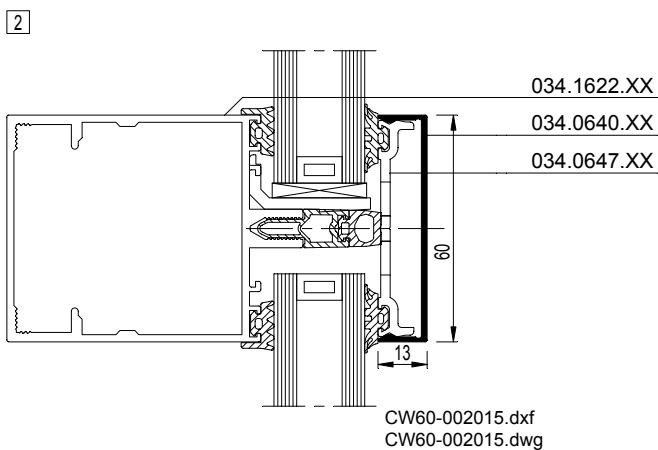
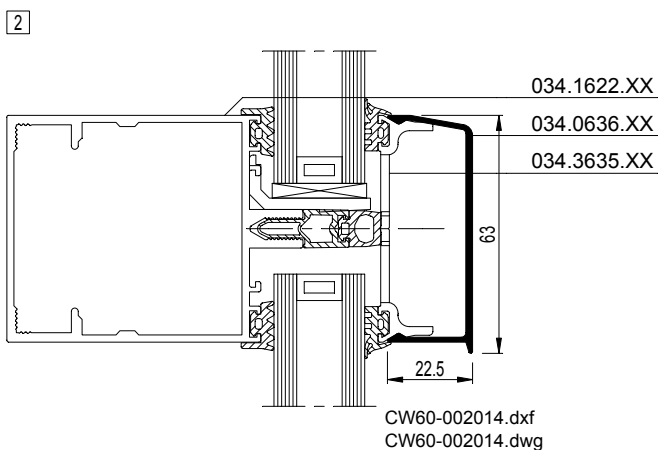
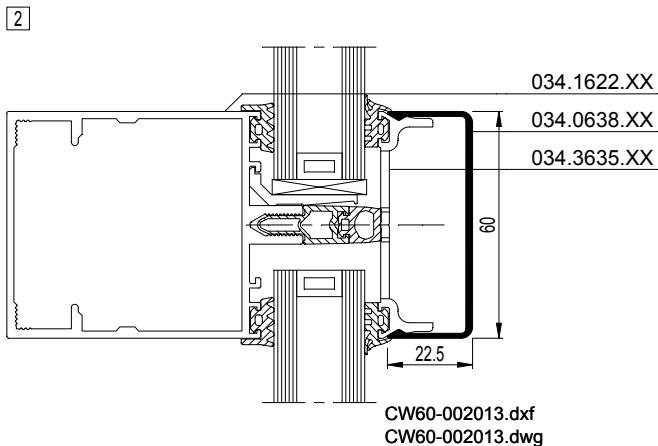
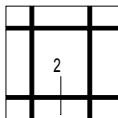

3	4	5	6	7

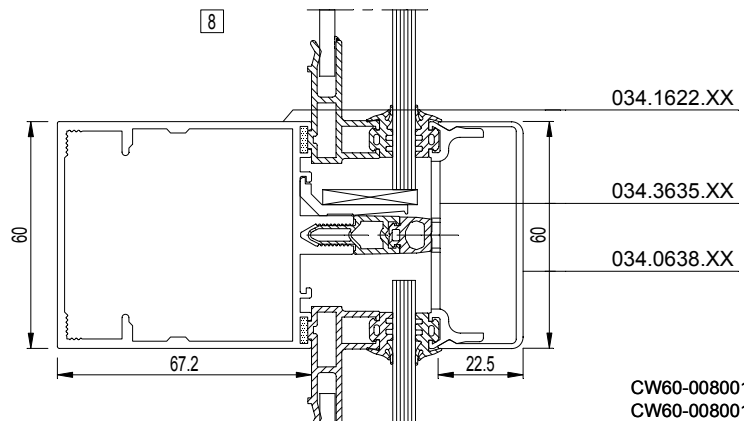
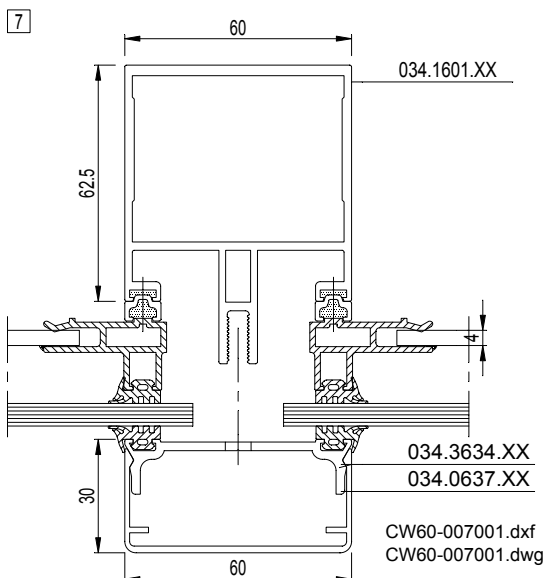
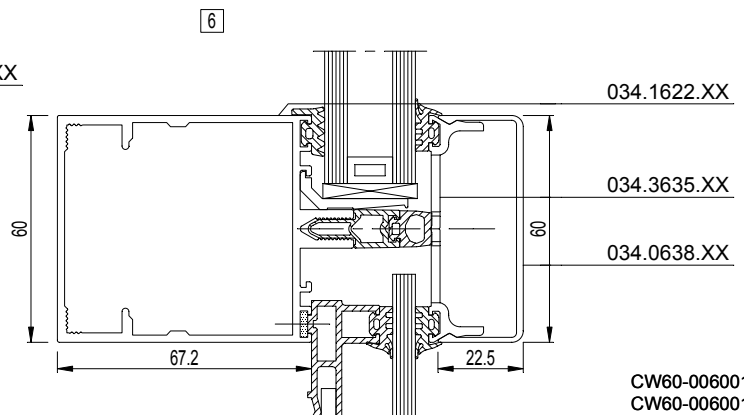
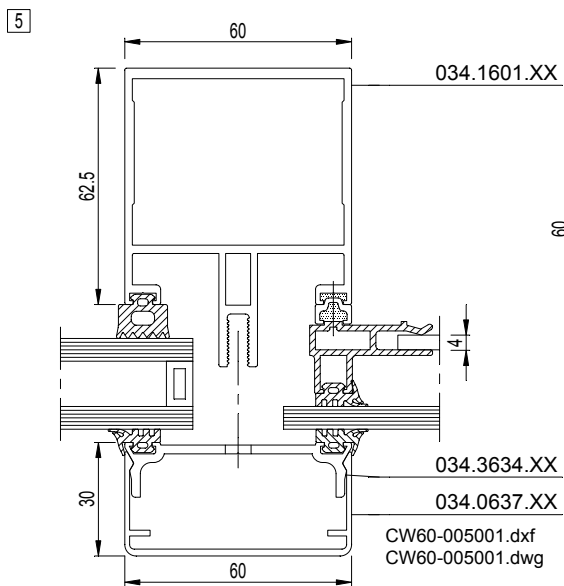
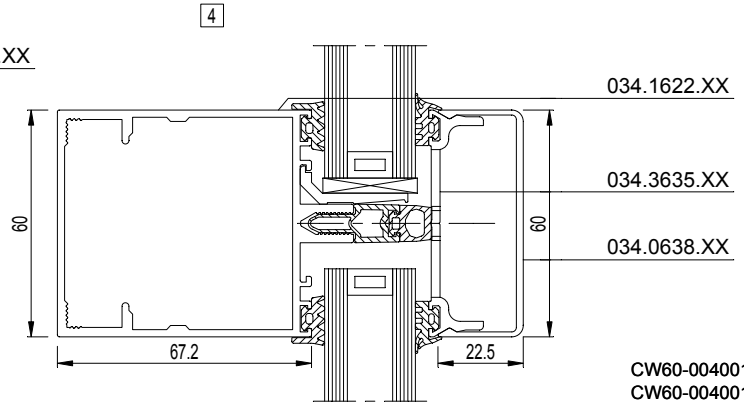
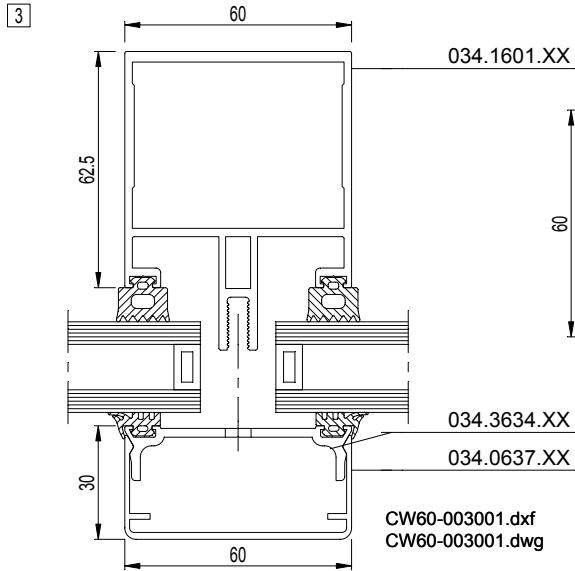

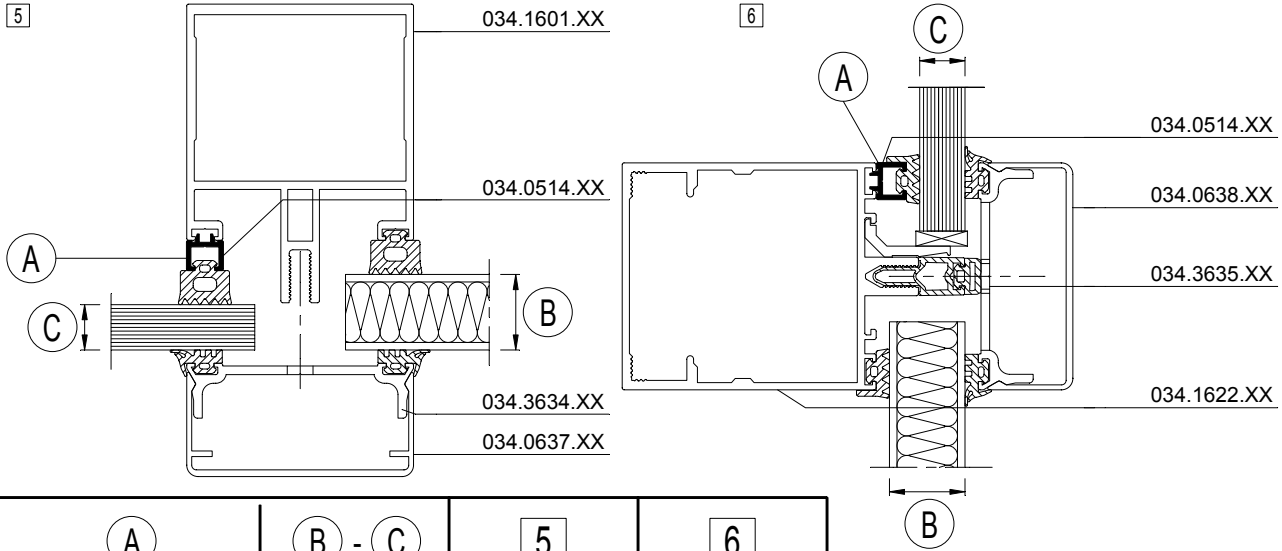
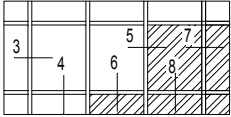

(A)	(B) - (C)	5	6
034.0517.XX		CW60-005002.dxf CW60-005002.dwg	CW60-006002.dxf CW60-006002.dwg
034.0617.XX		CW60-005003.dxf CW60-005003.dwg	CW60-006003.dxf CW60-006003.dwg
034.0514.XX		CW60-005004.dxf CW60-005004.dwg	CW60-006004.dxf CW60-006004.dwg
034.0618.XX		CW60-005005.dxf CW60-005005.dwg	CW60-006005.dxf CW60-006005.dwg
034.0615.XX		CW60-005006.dxf CW60-005006.dwg	CW60-006006.dxf CW60-006006.dwg
034.0619.XX		CW60-005007.dxf CW60-005007.dwg	CW60-006007.dxf CW60-006007.dwg
034.0610.04		CW60-005008.dxf CW60-005008.dwg	CW60-006008.dxf CW60-006008.dwg
034.0411.04		CW60-005009.dxf CW60-005009.dwg	CW60-006009.dxf CW60-006009.dwg
034.0616.XX		CW60-005010.dxf CW60-005010.dwg	CW60-006010.dxf CW60-006010.dwg
034.0420.XX		CW60-005011.dxf CW60-005011.dwg	CW60-006011.dxf CW60-006011.dwg

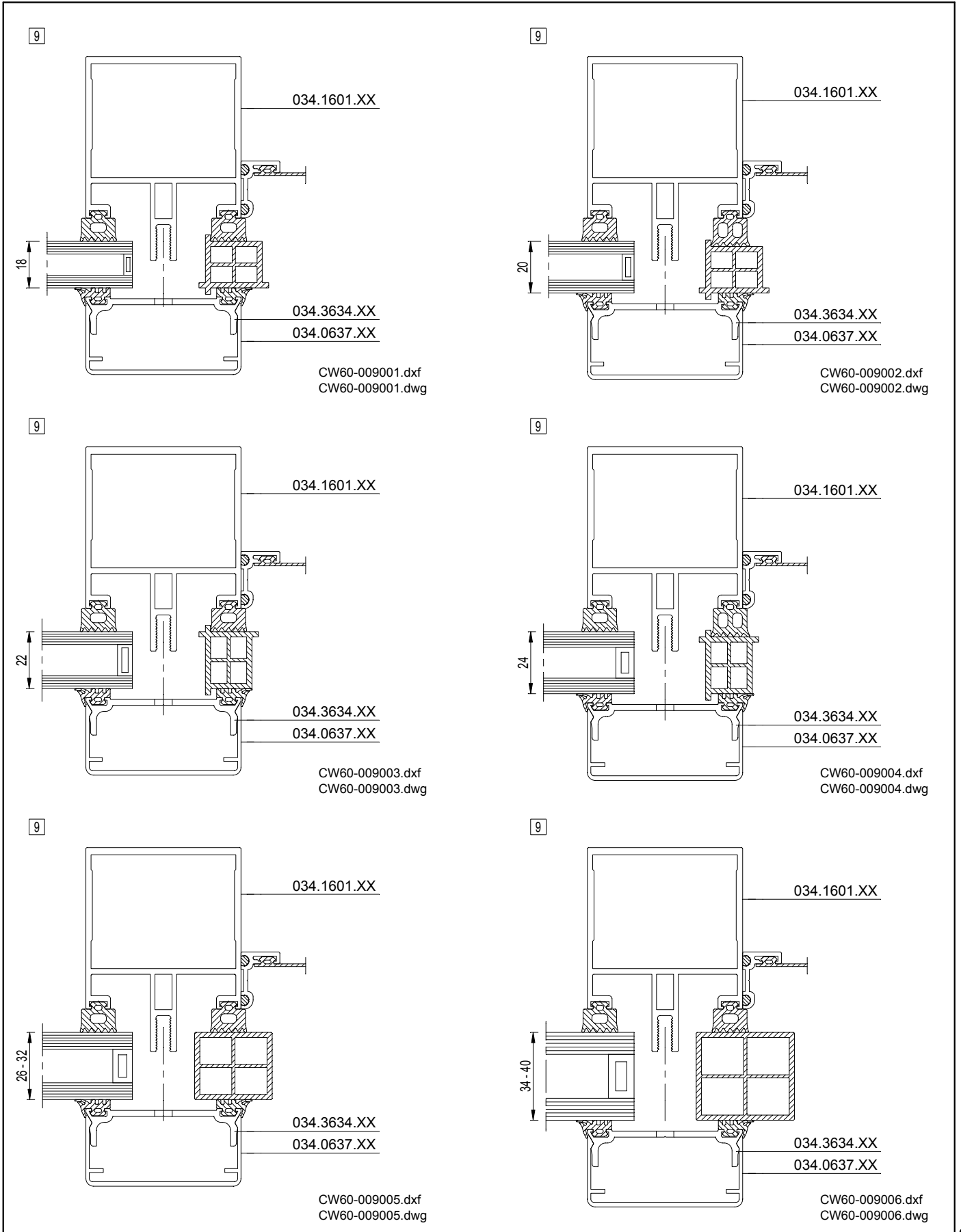
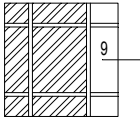

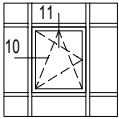

CS 68

10

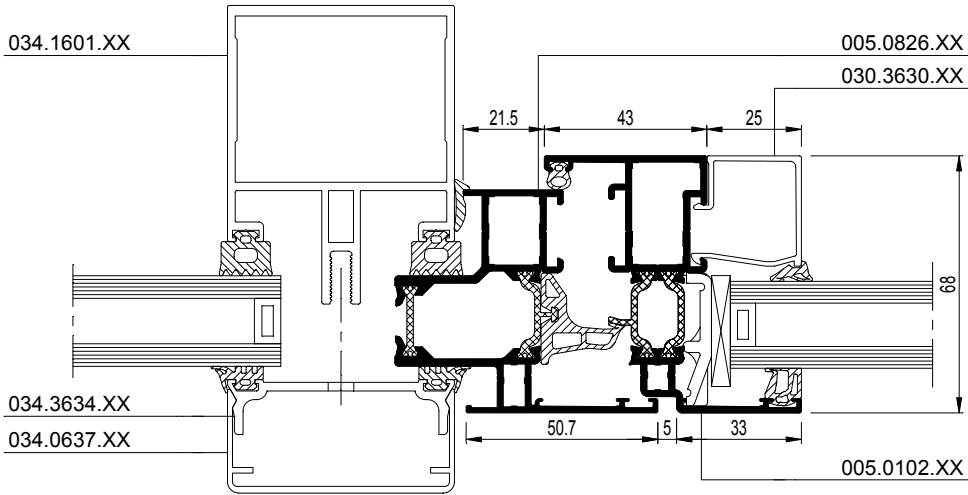

11

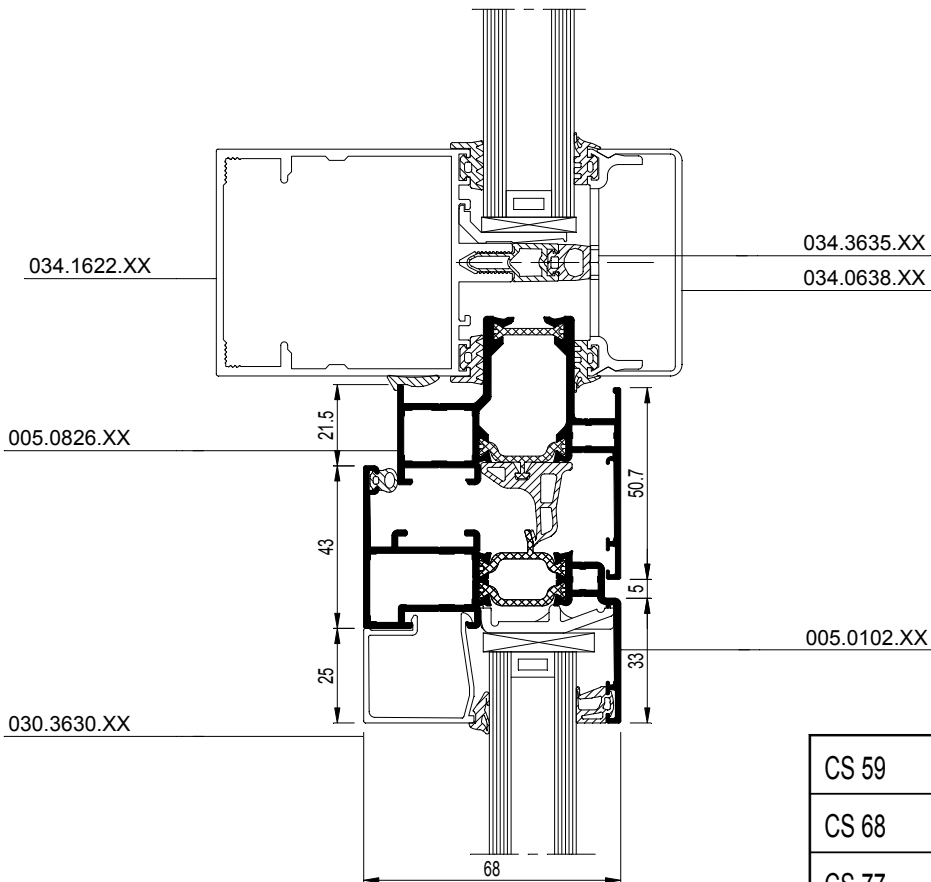

	10	11
CS 59	CW60-010001.dxf CW60-010001.dwg	CW60-011001.dxf CW60-011001.dwg
CS 68	CW60-010002.dxf CW60-010002.dwg	CW60-011002.dxf CW60-011002.dwg
CS 77	CW60-010003.dxf CW60-010003.dwg	CW60-011003.dxf CW60-011003.dwg
ECO	CW60-010005.dxf CW60-010005.dwg	CW60-011005.dxf CW60-011005.dwg
CS 86-HI	CW60-010006.dxf CW60-010006.dwg	CW60-011006.dxf CW60-011006.dwg

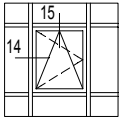

CS 68-HV

14

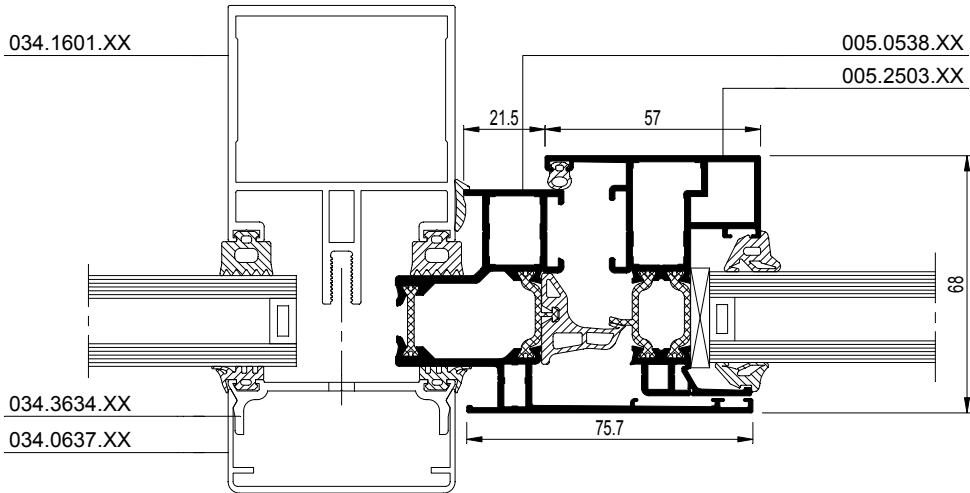

15

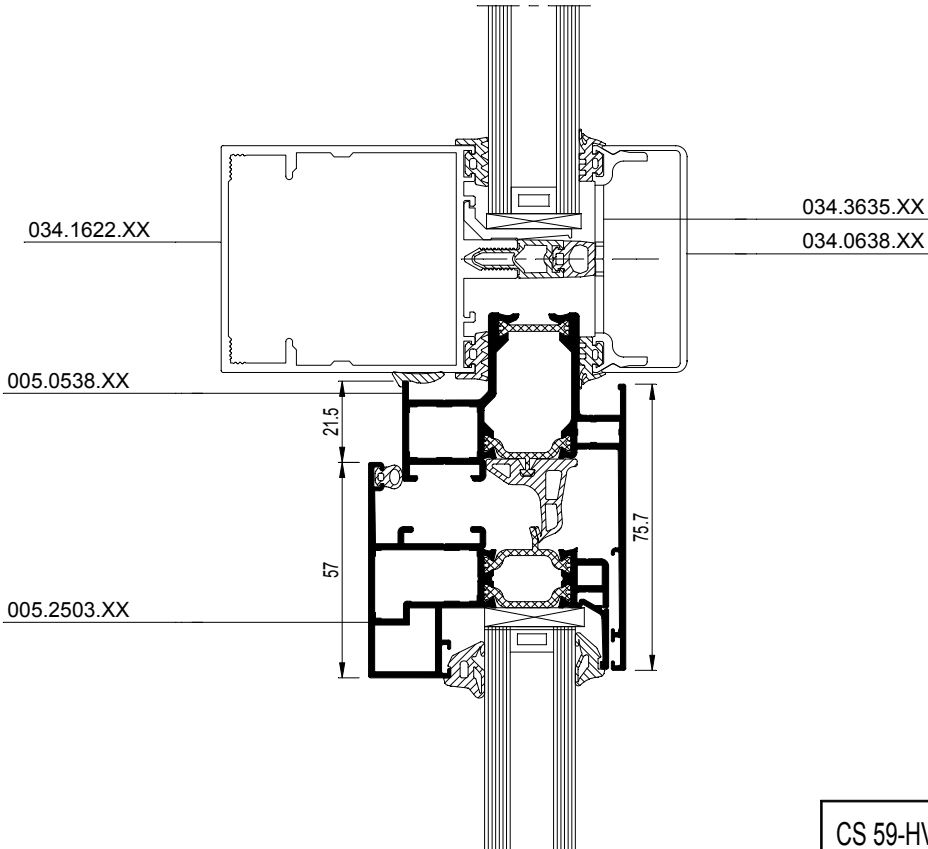

	14	15
CS 59-HV	CW60-014001.dxf CW60-014001.dwg	CW60-015001.dxf CW60-015001.dwg
CS 68-HV	CW60-014002.dxf CW60-014002.dwg	CW60-015002.dxf CW60-015002.dwg
CS 77-HV	CW60-014003.dxf CW60-014003.dwg	CW60-015003.dxf CW60-015003.dwg
CS 86-HI/HV	CW60-014004.dxf CW60-014004.dwg	CW60-015004.dxf CW60-015004.dwg

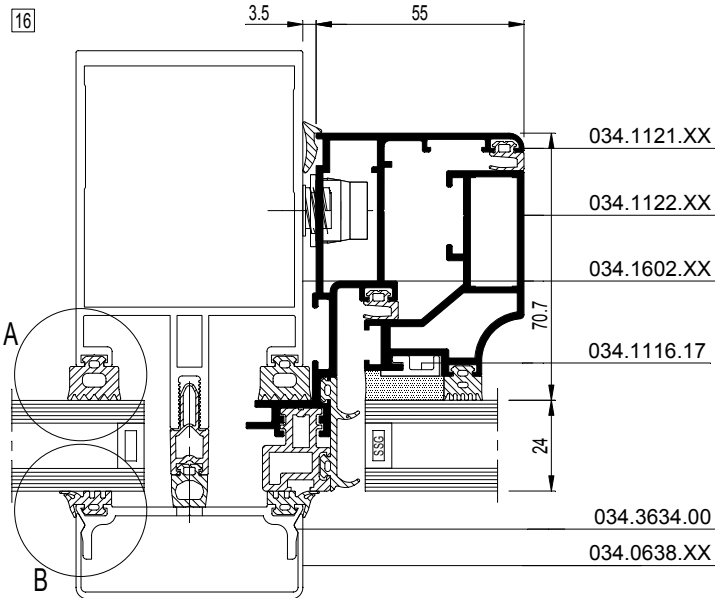
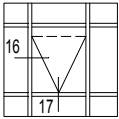

... .dxf
dwg

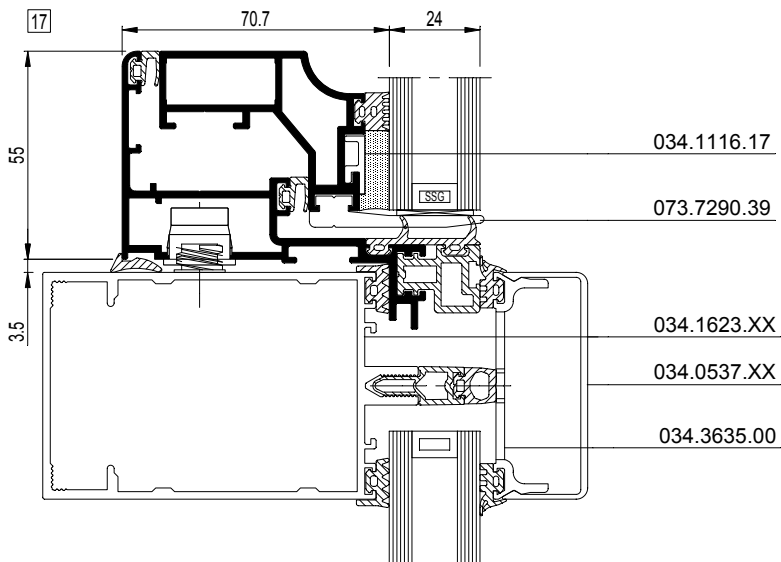

... .dxf
dwg



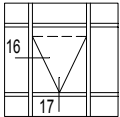

034.1121.XX + 034.1122.XX

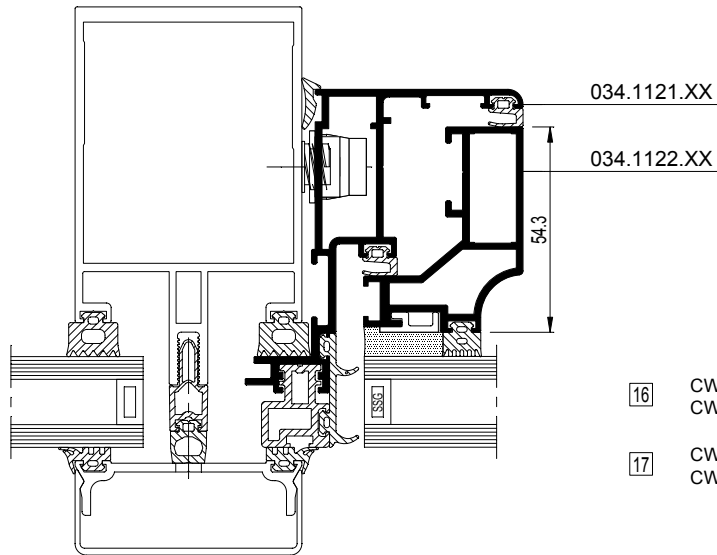

- 16 CW60-016001.dxf
CW60-016001.dwg
- 17 CW60-017001.dxf
CW60-017001.dwg

034.0155.XX + 034.0156.XX

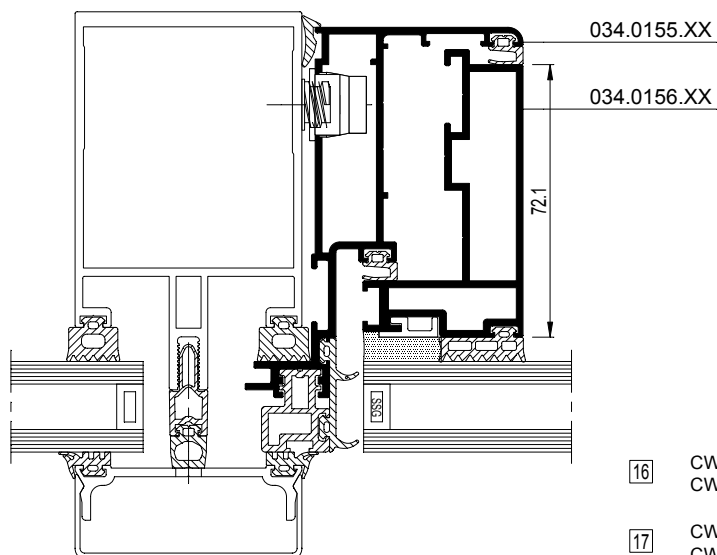

- 16 CW60-016004.dxf
CW60-016004.dwg
- 17 CW60-017002.dxf
CW60-017002.dwg

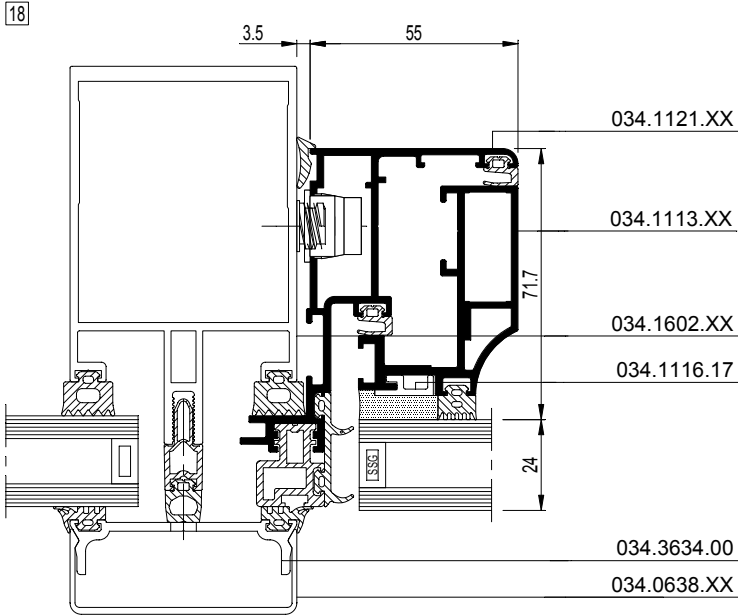
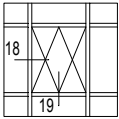

... .dxf
dwg

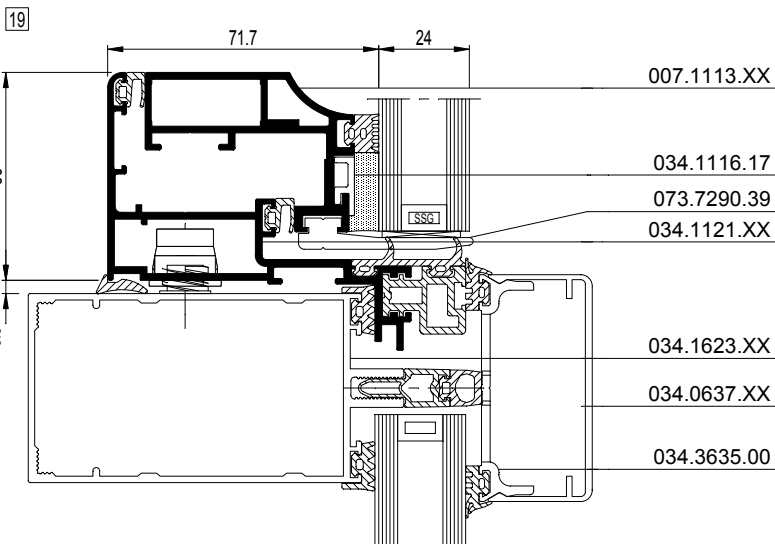

... .dxf
dwg



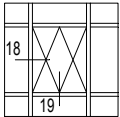

034.1121.XX + 034.1113.XX

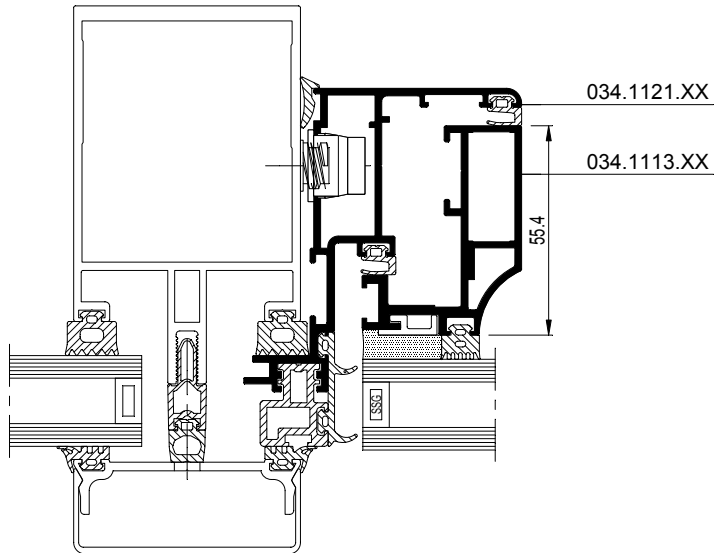

- 18 CW60-018001.dxf
CW60-018001.dwg
- 19 CW60-019001.dxf
CW60-019001.dwg

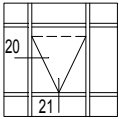

20

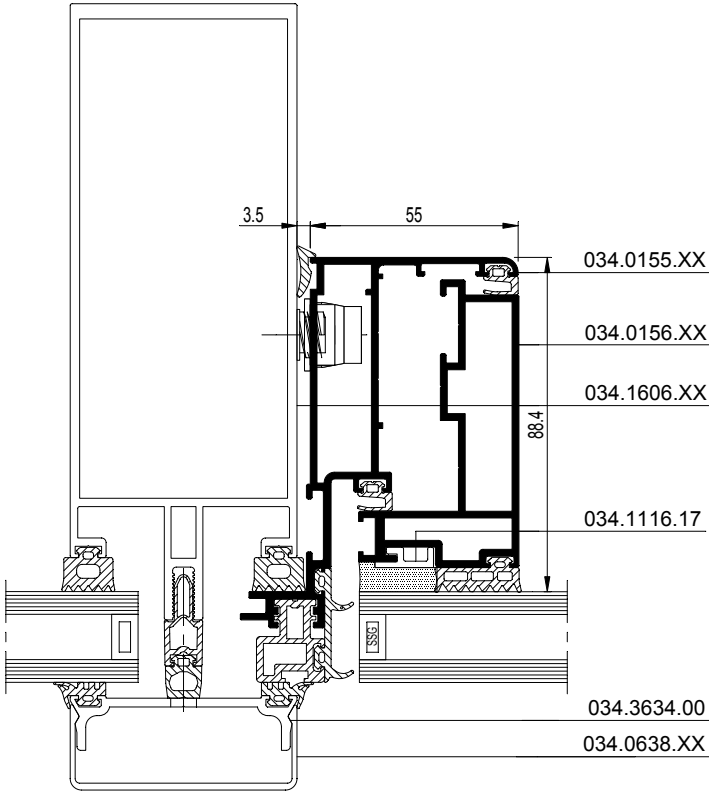

CW60-020001.dxf
 CW60-020001.dwg

21

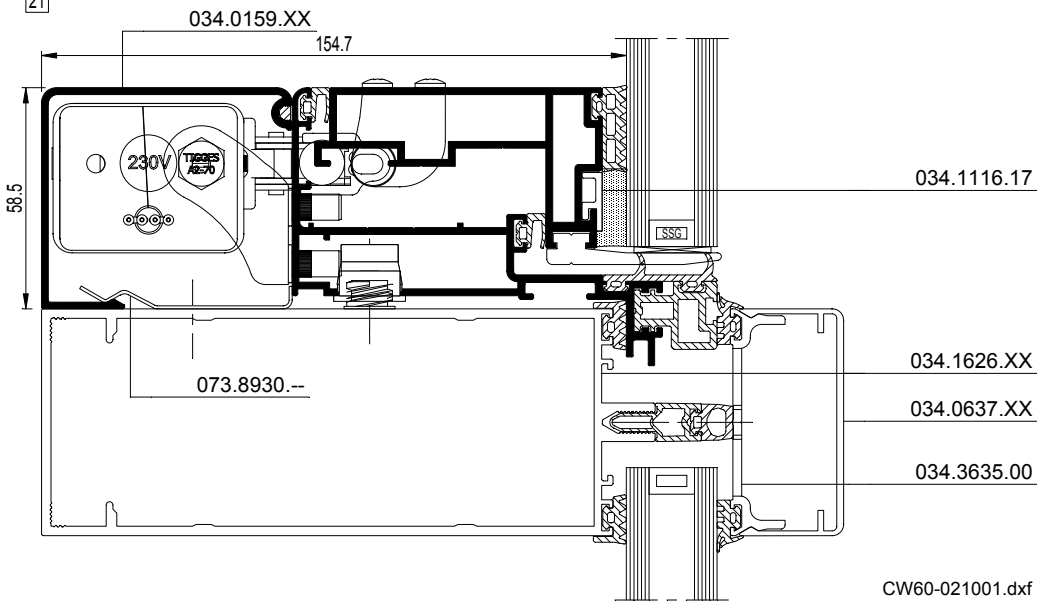

CW60-021001.dxf
 CW60-021001.dwg



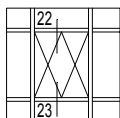

22

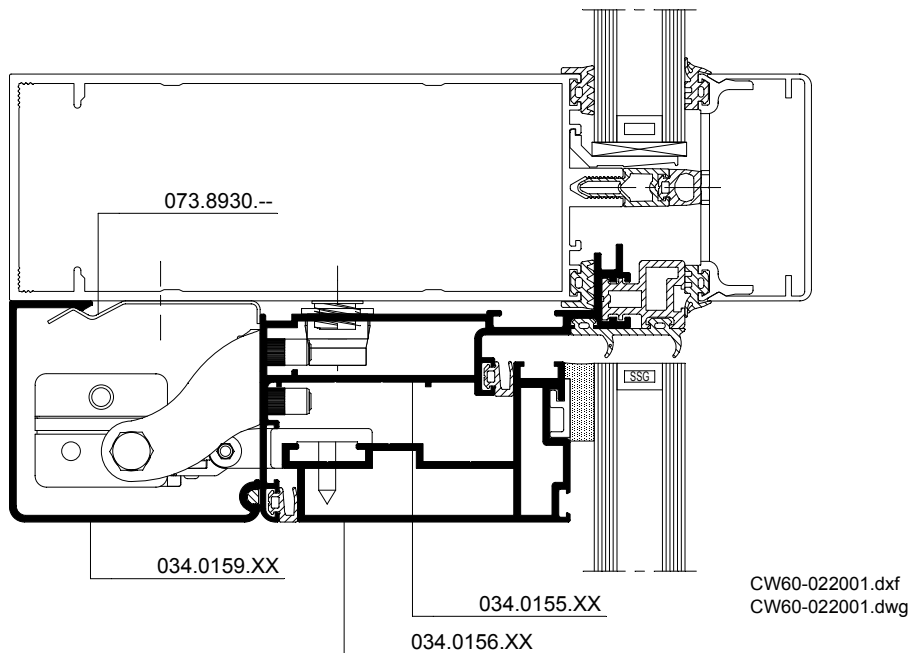

23

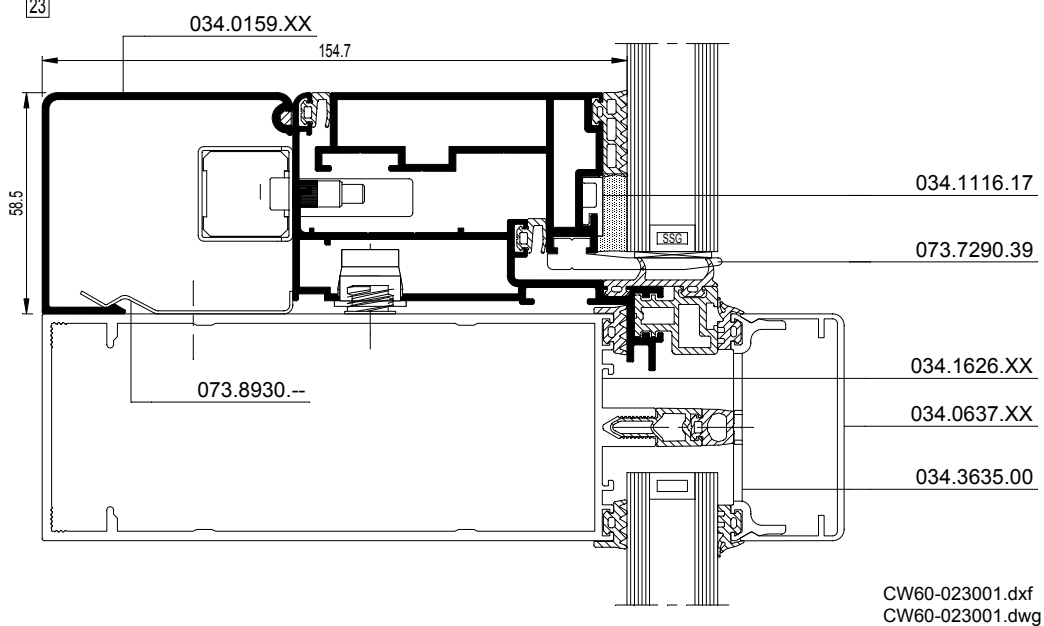

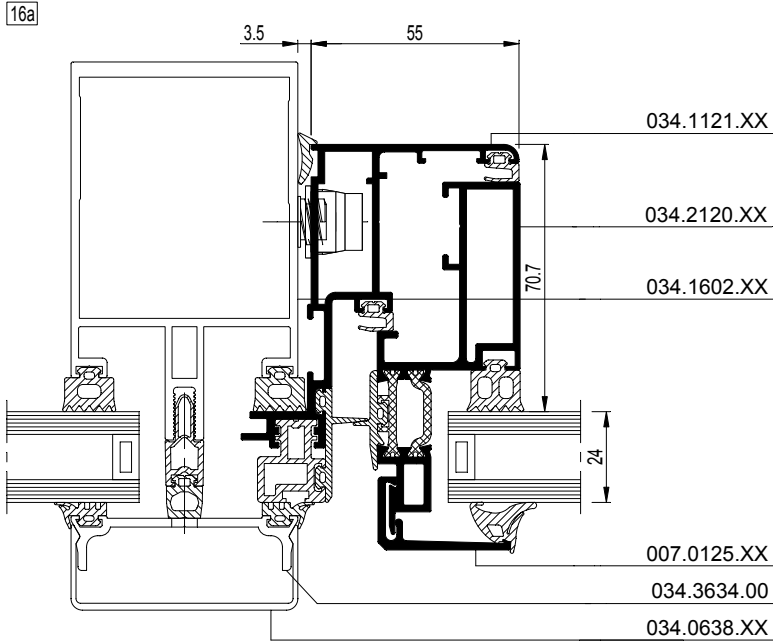
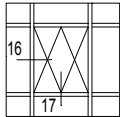
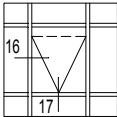

... .dxf
dwg

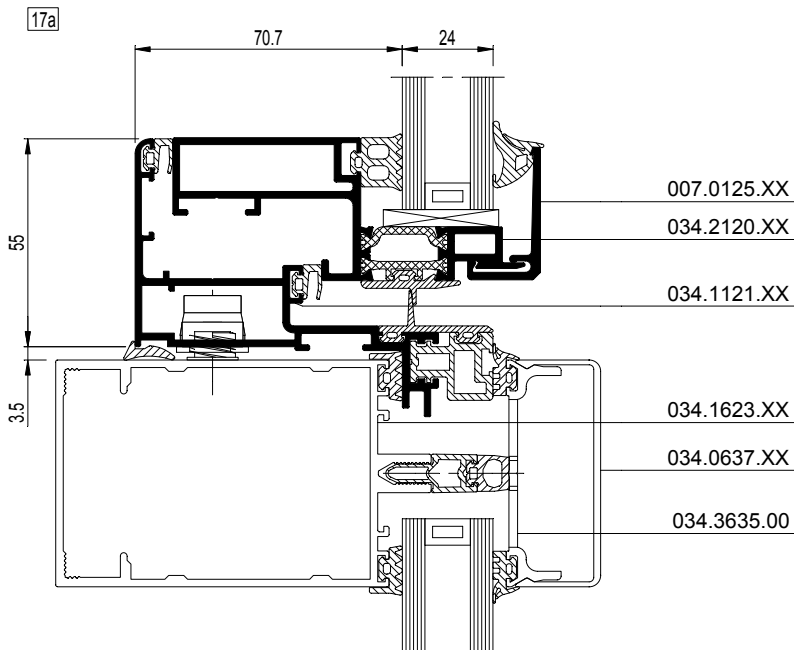

... .dxf
dwg



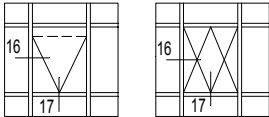

034.1121.XX + 034.2120.XX

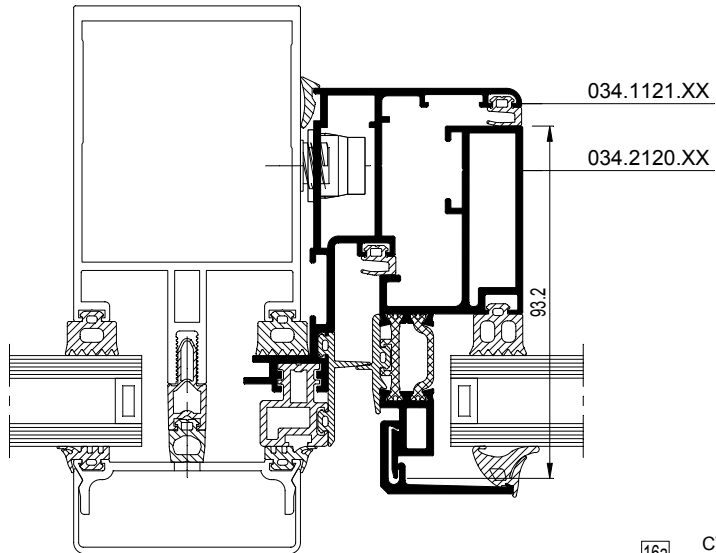

16a CW60-016007.dxf
 CW60-016007.dwg

17a CW60-017003.dxf
 CW60-017003.dwg

034.0155.XX + 034.0157.XX

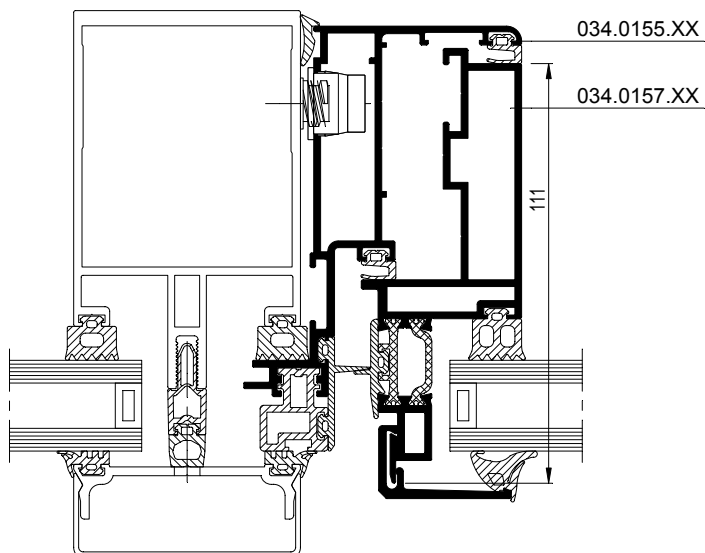

16a CW60-016010.dxf
 CW60-016010.dwg

17a CW60-017004.dxf
 CW60-017004.dwg



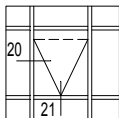

20a

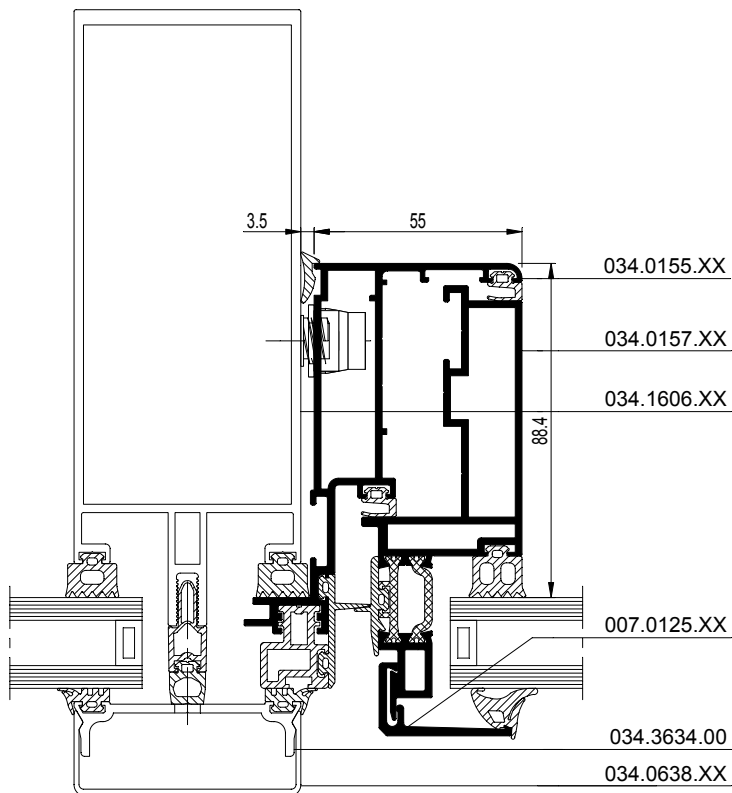

CW60-020002.dxf
 CW60-020002.dwg

31a

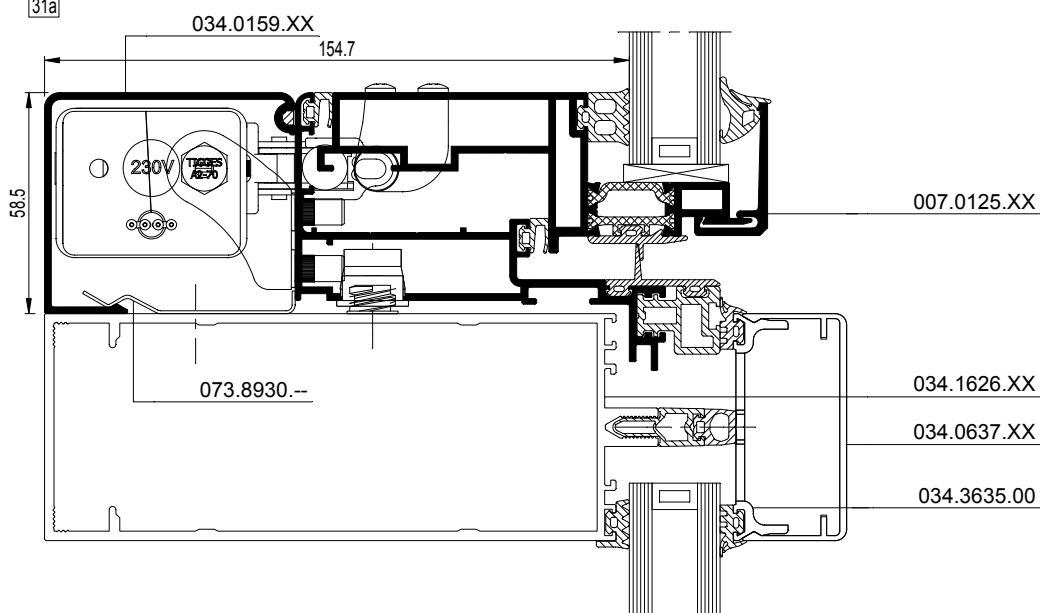

CW60-021002.dxf
 CW60-021002.dwg

22	
23	

22a

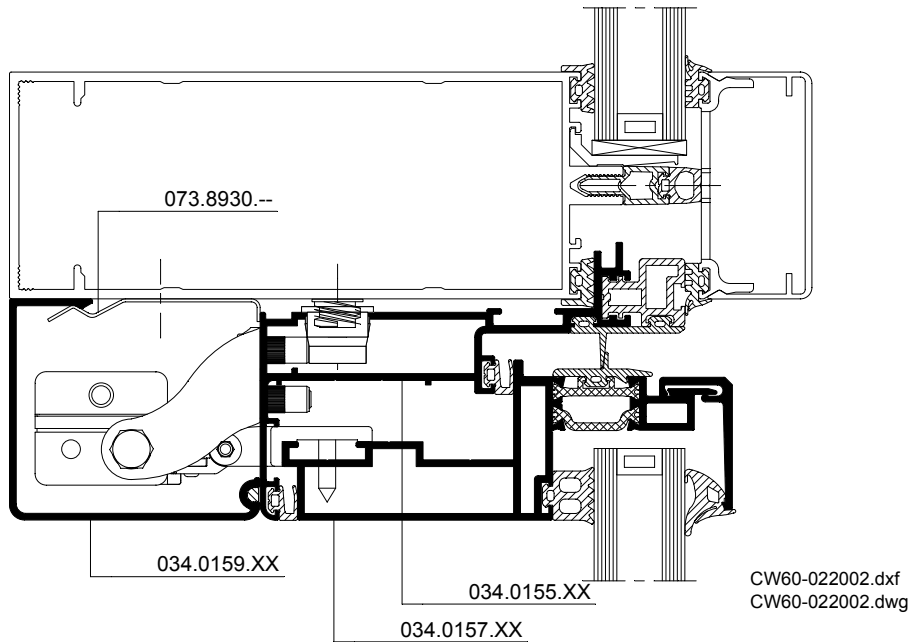

23a

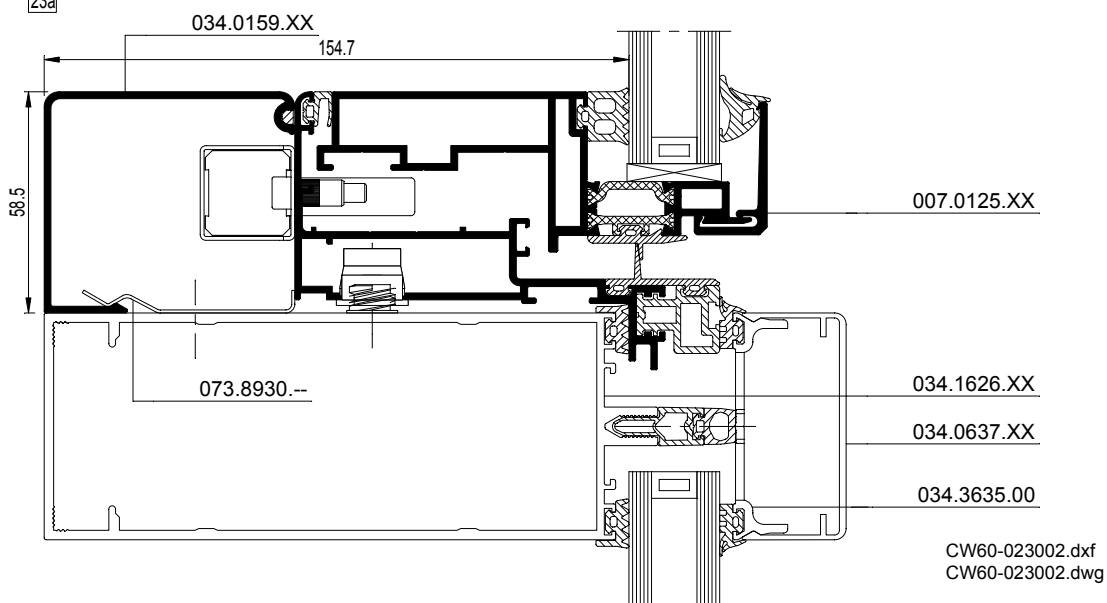

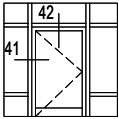

CS 68

41

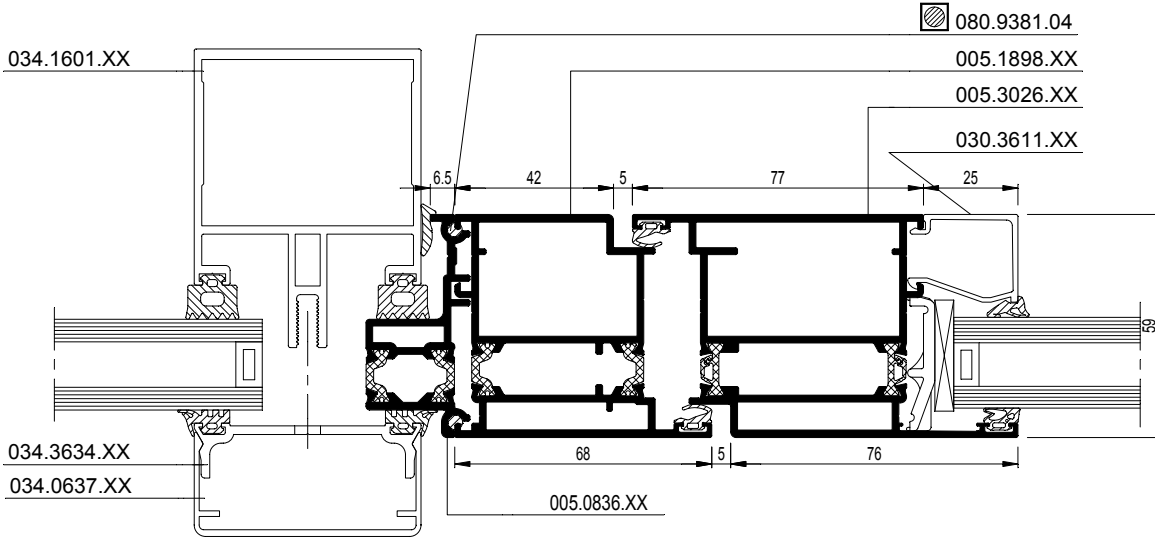

42

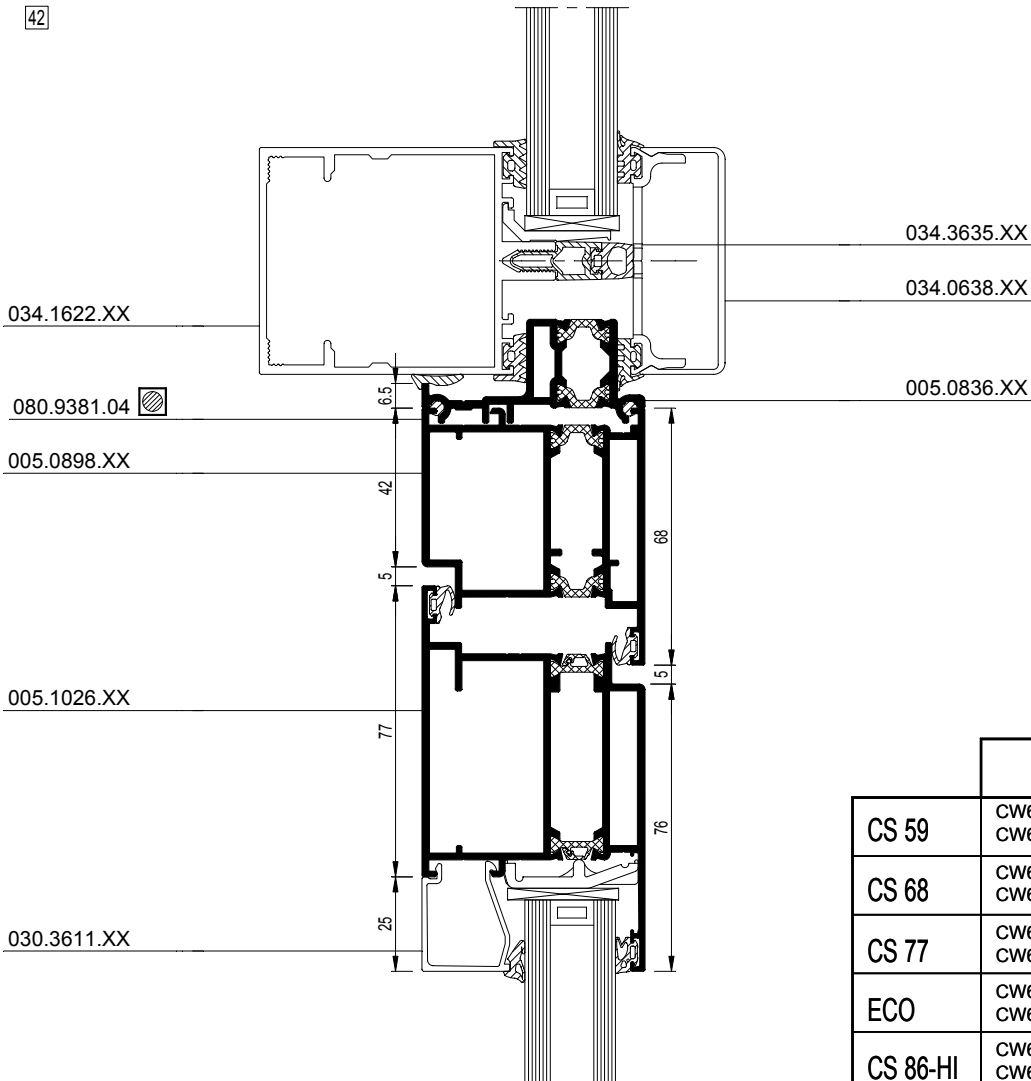

	41	42
CS 59	CW60-041001.dxf CW60-041001.dwg	CW60-042001.dxf CW60-042001.dwg
CS 68	CW60-041002.dxf CW60-041002.dwg	CW60-042002.dxf CW60-042002.dwg
CS 77	CW60-041003.dxf CW60-041003.dwg	CW60-042003.dxf CW60-042003.dwg
ECO	CW60-041004.dxf CW60-041004.dwg	CW60-042004.dxf CW60-042004.dwg
CS 86-HI	CW60-041005.dxf CW60-041005.dwg	CW60-042005.dxf CW60-042005.dwg

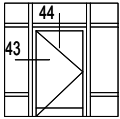

CS 68

43

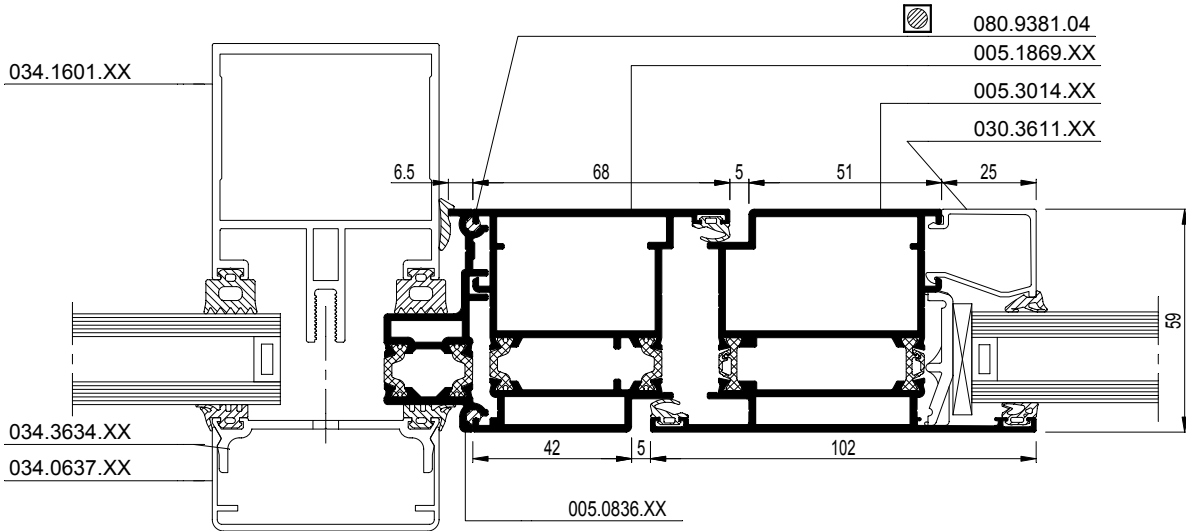

44

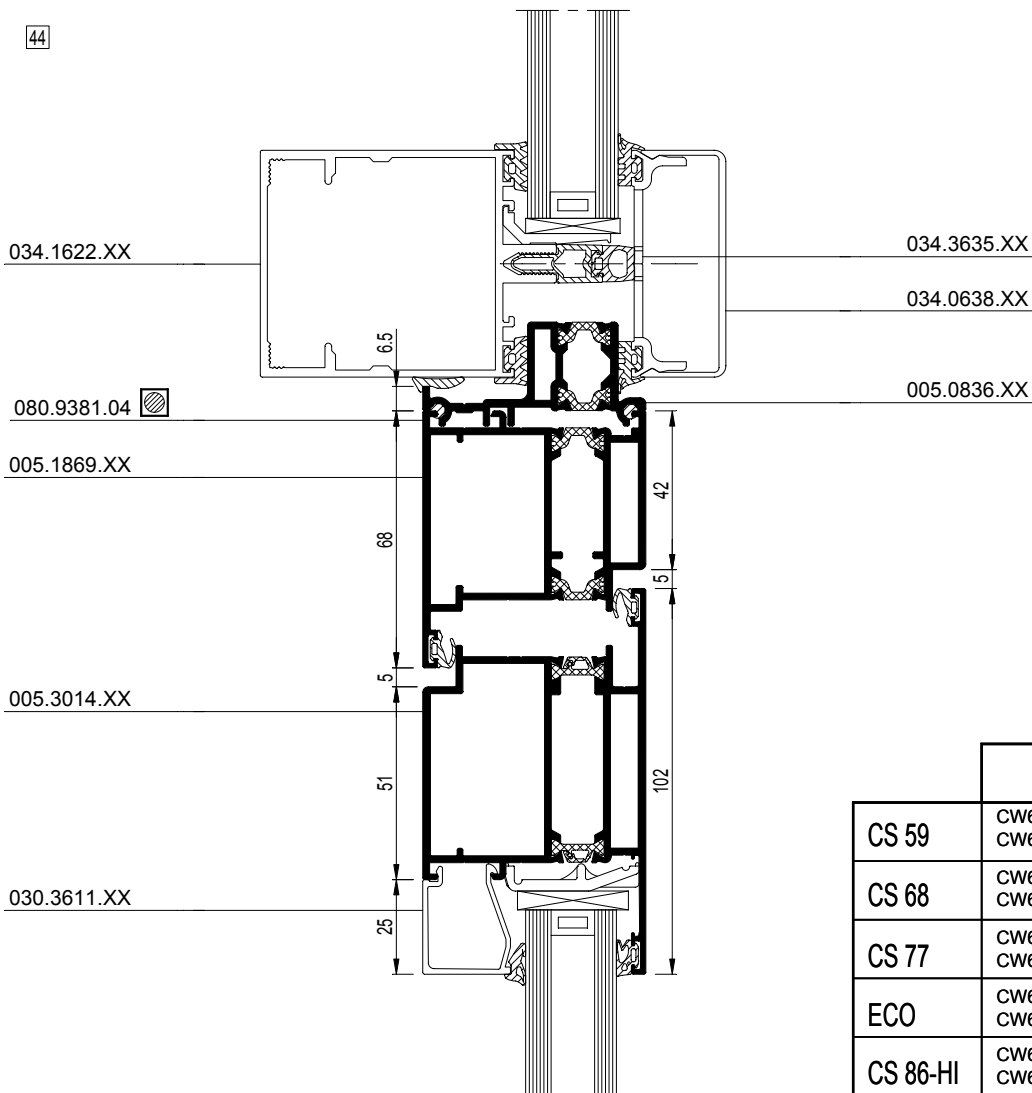

	43	44
CS 59	CW60-043001.dxf CW60-043001.dwg	CW60-044001.dxf CW60-044001.dwg
CS 68	CW60-043002.dxf CW60-043002.dwg	CW60-044002.dxf CW60-044002.dwg
CS 77	CW60-043003.dxf CW60-043003.dwg	CW60-044003.dxf CW60-044003.dwg
ECO	CW60-043004.dxf CW60-043004.dwg	CW60-044004.dxf CW60-044004.dwg
CS 86-HI	CW60-043005.dxf CW60-043005.dwg	CW60-044005.dxf CW60-044005.dwg

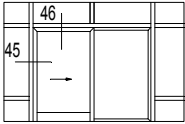

CP 130

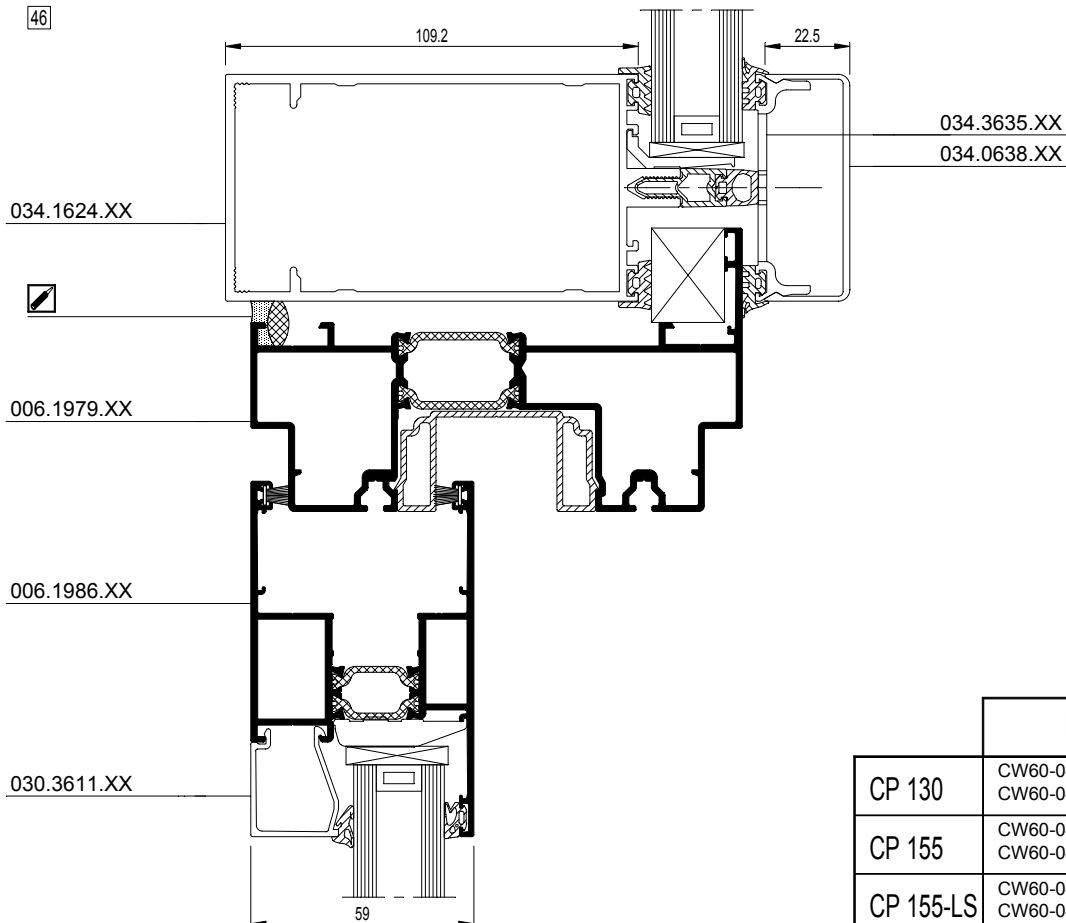
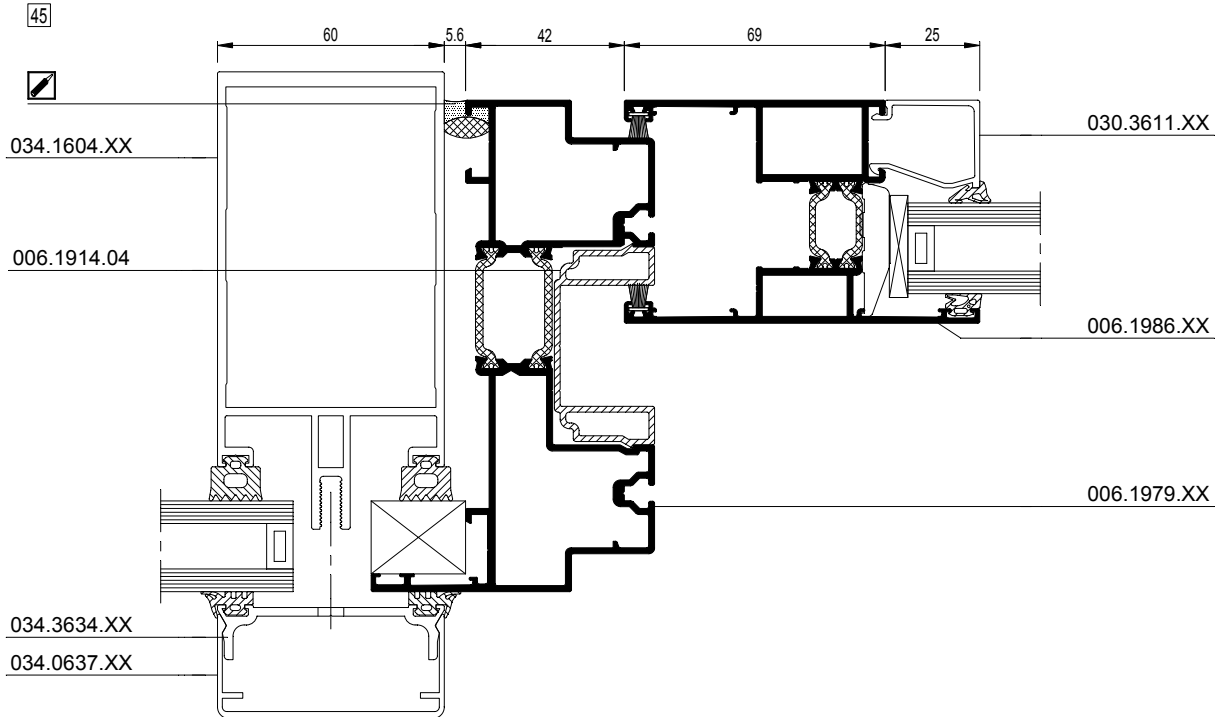

	45	46
CP 130	CW60-045001.dxf CW60-045001.dwg	CW60-046001.dxf CW60-046001.dwg
CP 155	CW60-045002.dxf CW60-045002.dwg	CW60-046002.dxf CW60-046002.dwg
CP 155-LS	CW60-045003.dxf CW60-045003.dwg	CW60-046003.dxf CW60-046003.dwg

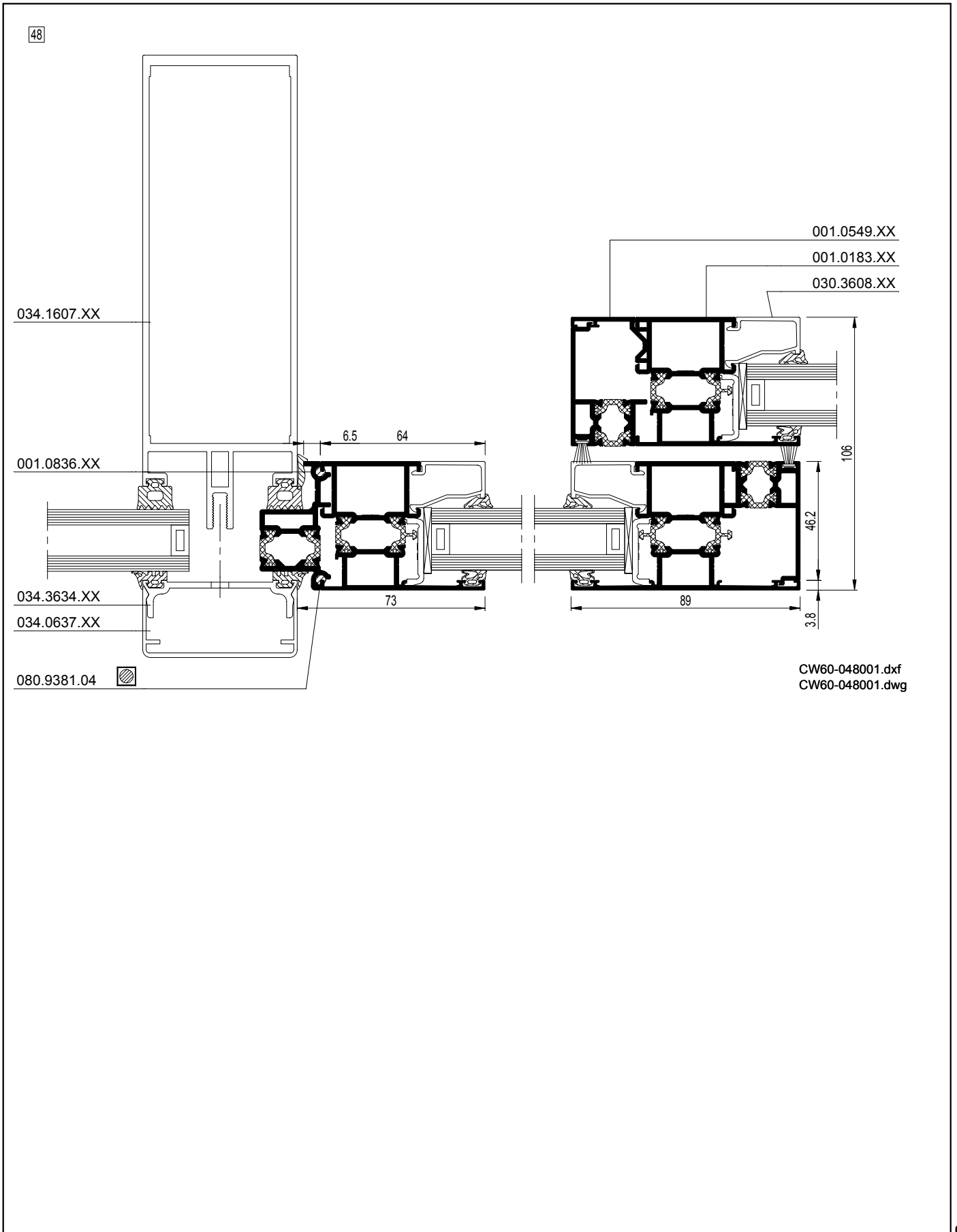
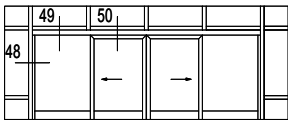

CW60-048001.dxf
 CW60-048001.dwg

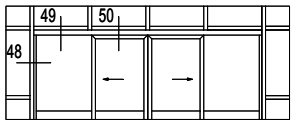

49

Mechanisme automatische deur
 Mécanisme pour porte automatique
 Mechanism automatic door
 Automat für Schiebetür

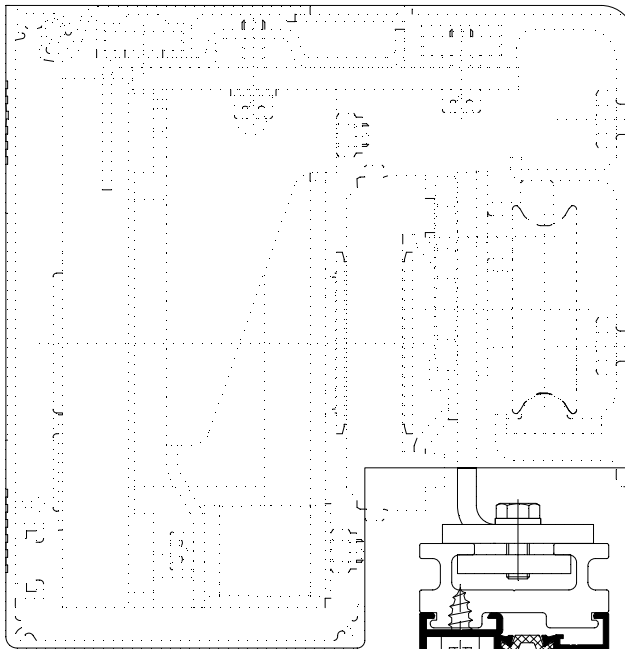

034.1622.XX

034.0638.XX

034.3635.XX

001.0836.XX

080.9381.04

005.0535.XX

001.0547.XX

001.0183.XX

030.3608.XX

001.0562.XX

106

261.5

CW60-049001.dxf
 CW60-049001.dwg

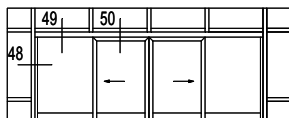

50

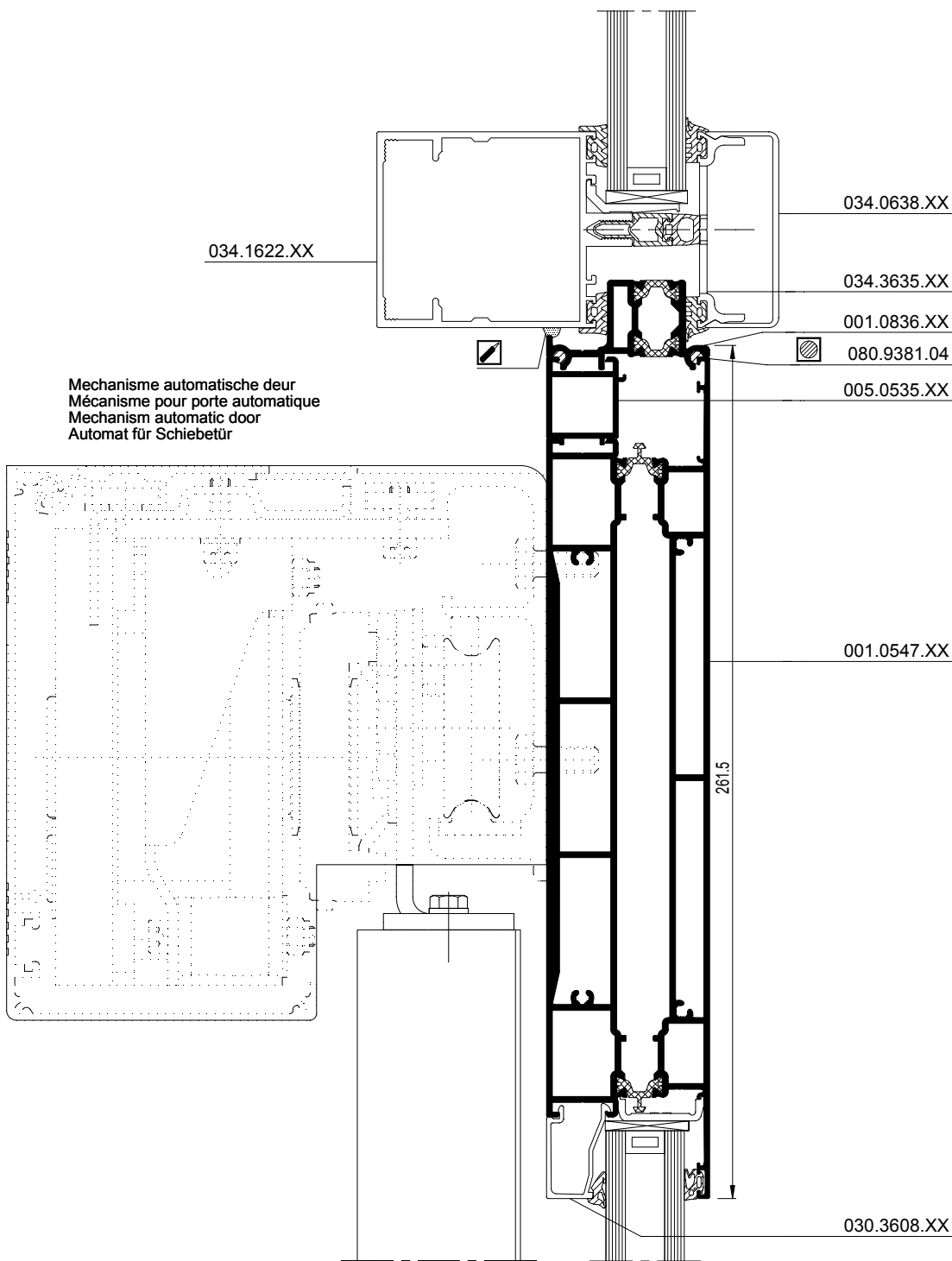

Mechanisme automatische deur
 Mécanisme pour porte automatique
 Mechanism automatic door
 Automat für Schiebetür

CW60-050001.dxf
 CW60-050001.dwg

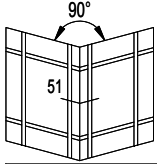

51

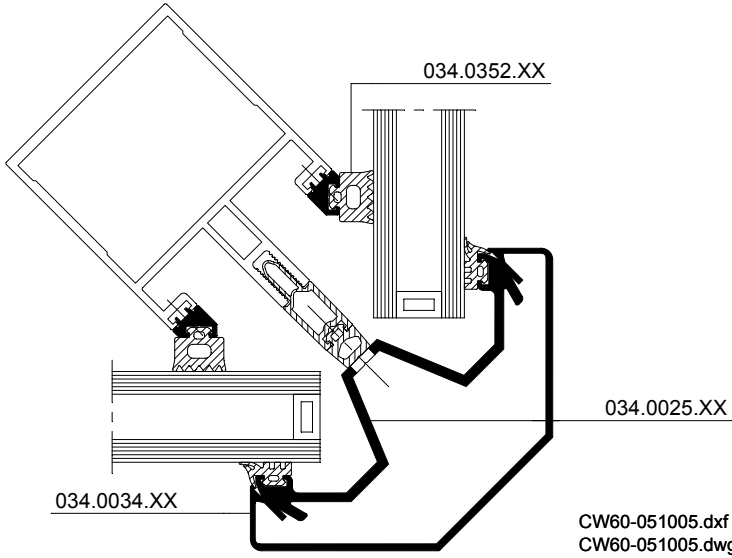

51

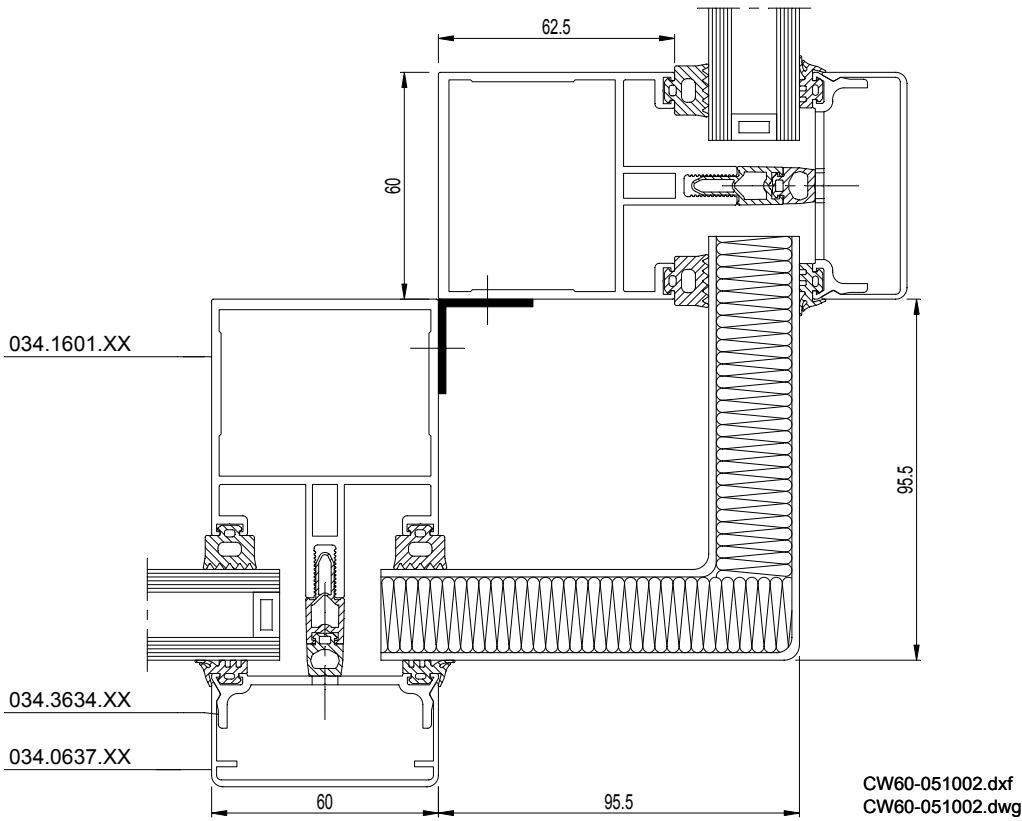

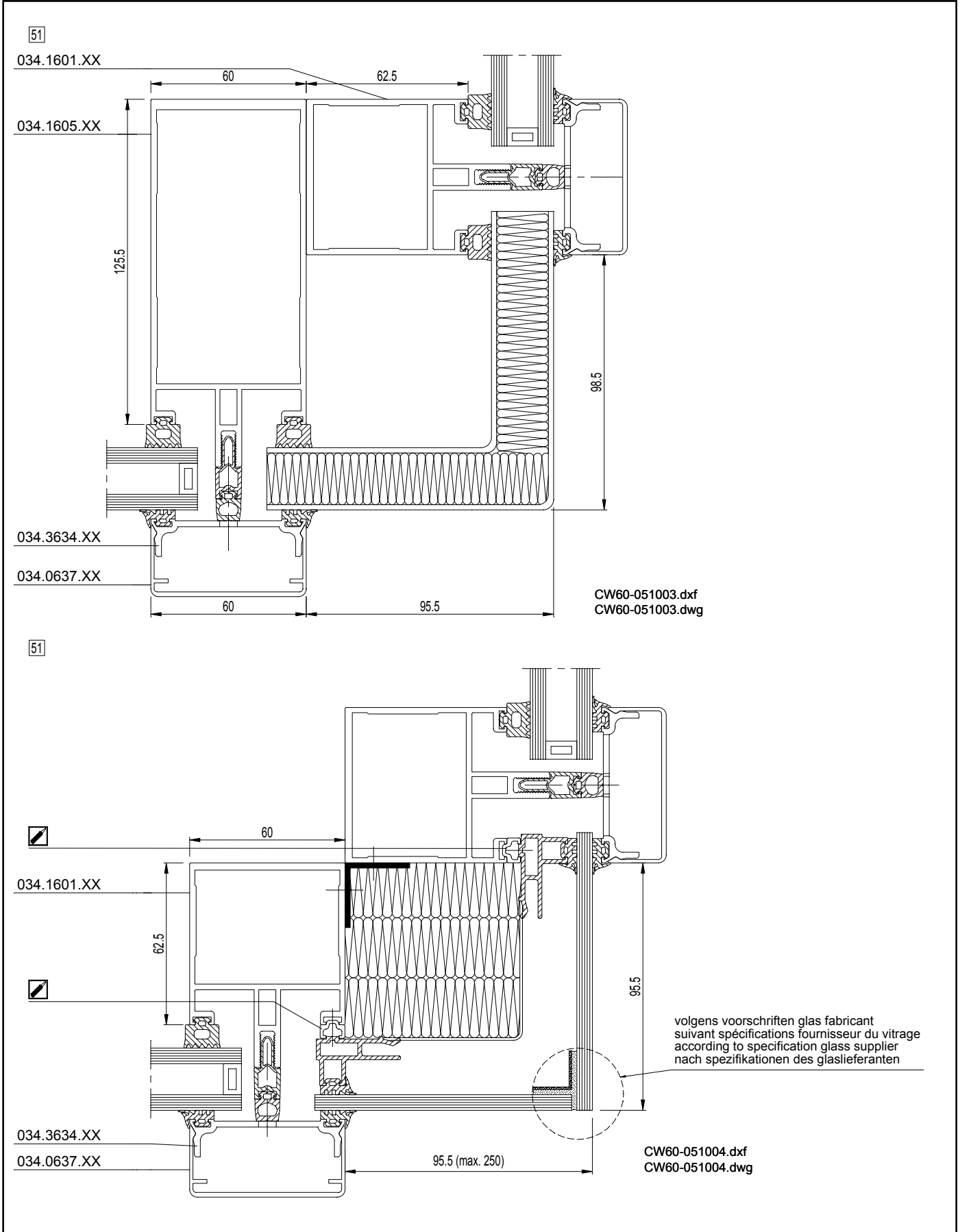
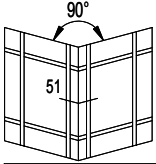

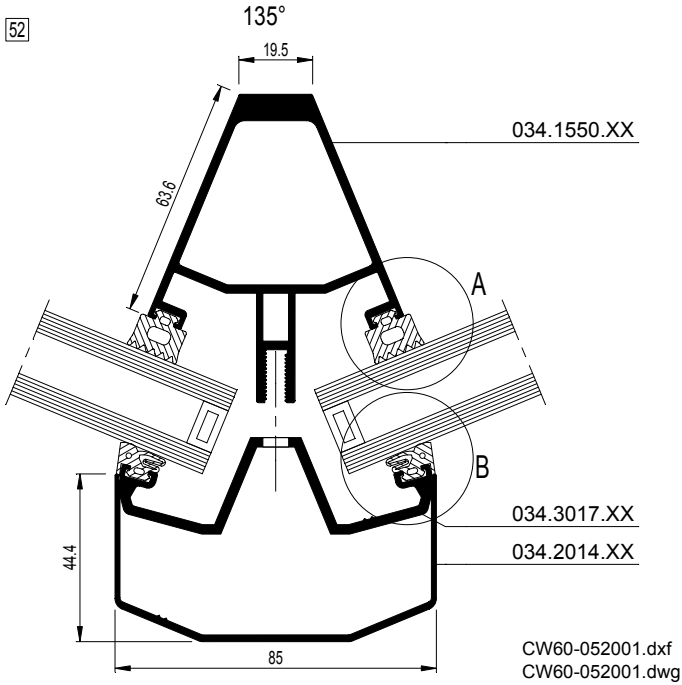
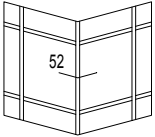

MIN. 105°

MAX. 155°

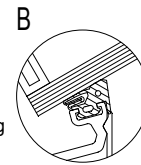
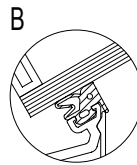
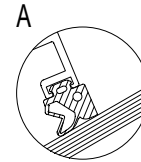
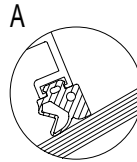

CW60-052002.dxf
 CW60-052002.dwg

CW60-052003.dxf
 CW60-052003.dwg

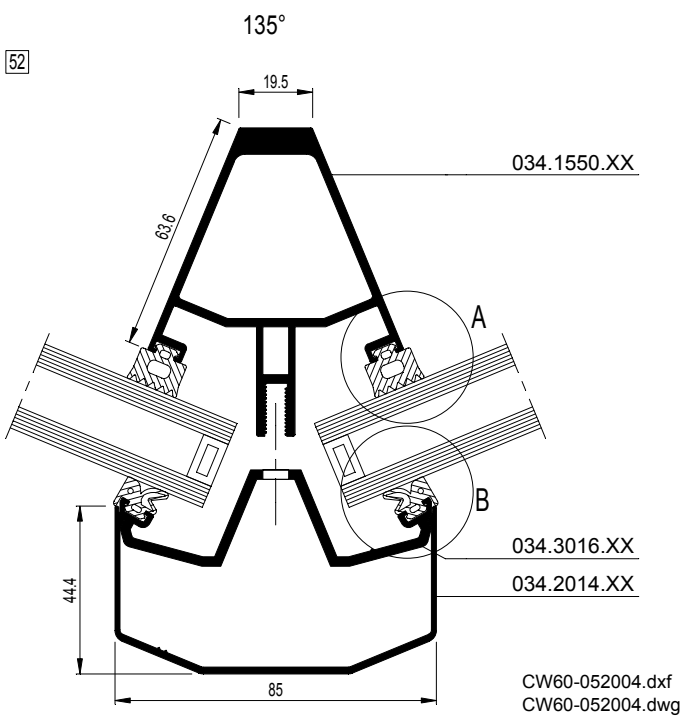

MIN. 105°

MAX. 140°

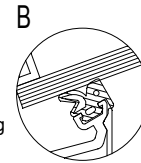
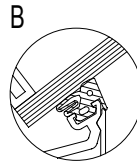
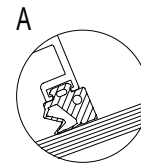
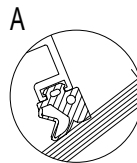

CW60-052005.dxf
 CW60-052005.dwg

CW60-052006.dxf
 CW60-052006.dwg

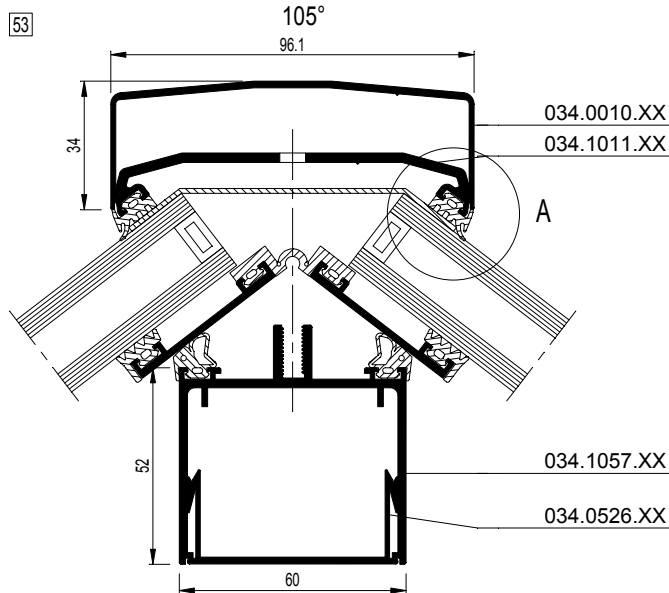
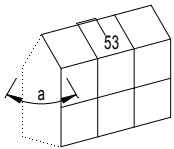

90° - 135°

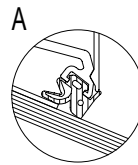

CW60-053002.dxf
 CW60-053002.dwg

CW60-053001.dxf
 CW60-053001.dwg

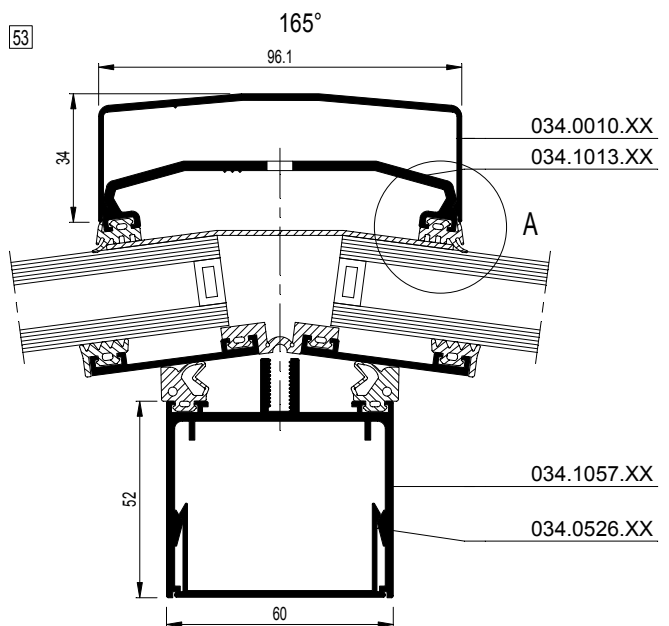

135° - 170°

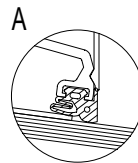

CW60-053004.dxf
 CW60-053004.dwg

CW60-053003.dxf
 CW60-053003.dwg

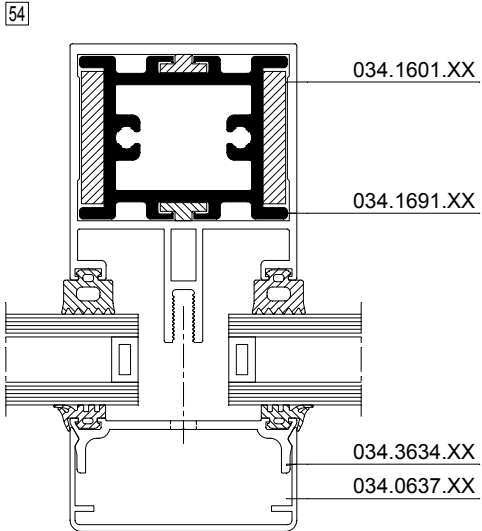
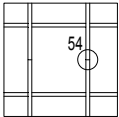

☞dxf
dwg

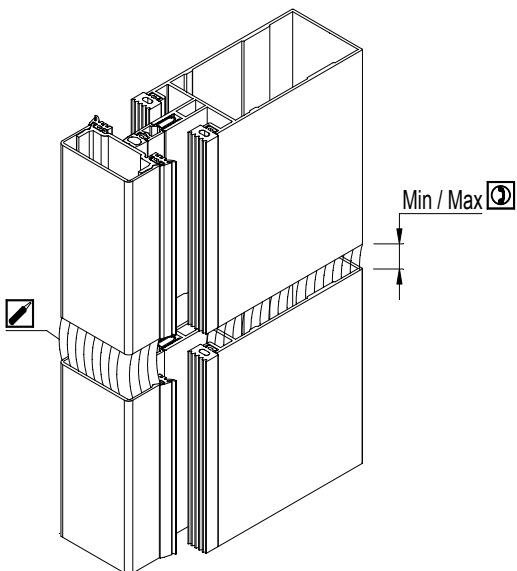
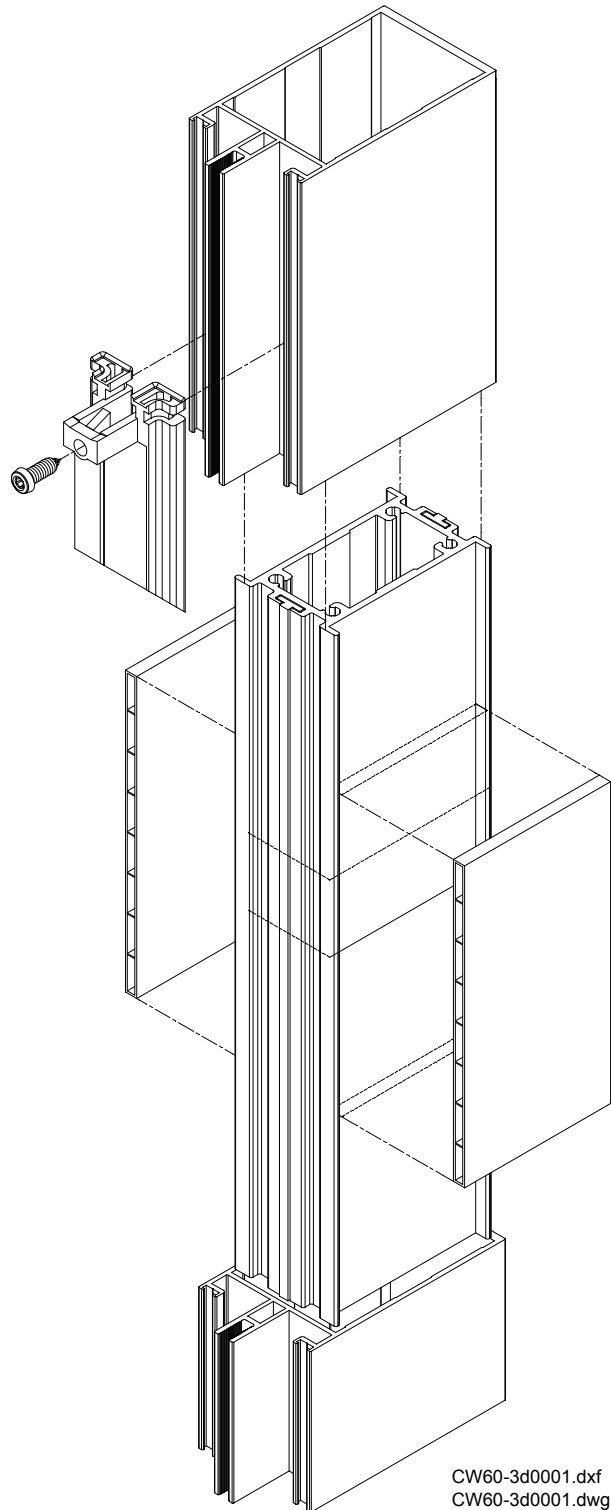

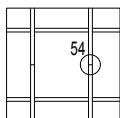

034.1691.XX

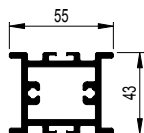

CW60-054001.dxf
 CW60-054001.dwg

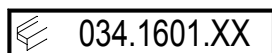

034.1692.XX

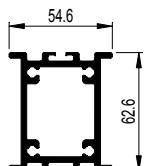

CW60-054002.dxf
 CW60-054002.dwg

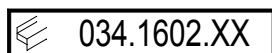

034.1693.XX

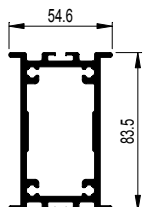

CW60-054003.dxf
 CW60-054003.dwg

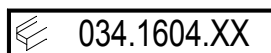

034.1694.XX

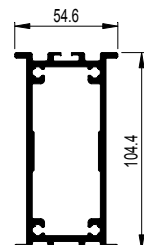

CW60-054004.dxf
 CW60-054004.dwg

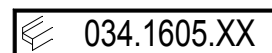

034.1695.XX

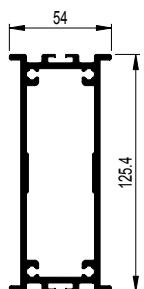

CW60-054005.dxf
 CW60-054005.dwg

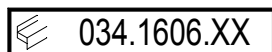

034.1696.XX

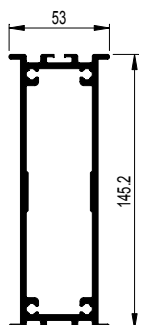

CW60-054006.dxf
 CW60-054006.dwg

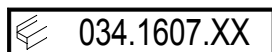

034.1697.XX

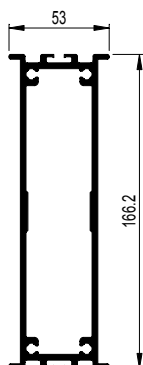

CW60-054007.dxf
 CW60-054007.dwg

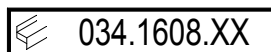

034.1699.XX

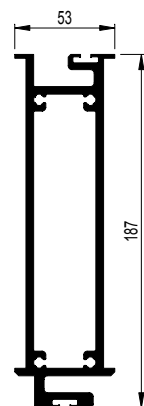

CW60-054008.dxf
 CW60-054008.dwg

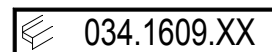

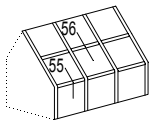

55

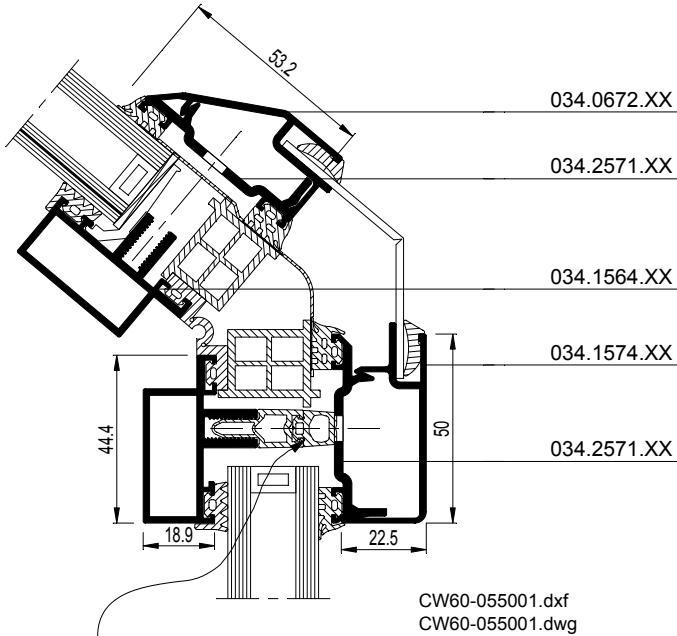

Horizontale compartimentering is verplicht
 Compartimentation horizontale est obligatoire
 Horizontal compartmentalisation is obligatory
 Horizontale Kompartimentierung ist verpflichtet

55

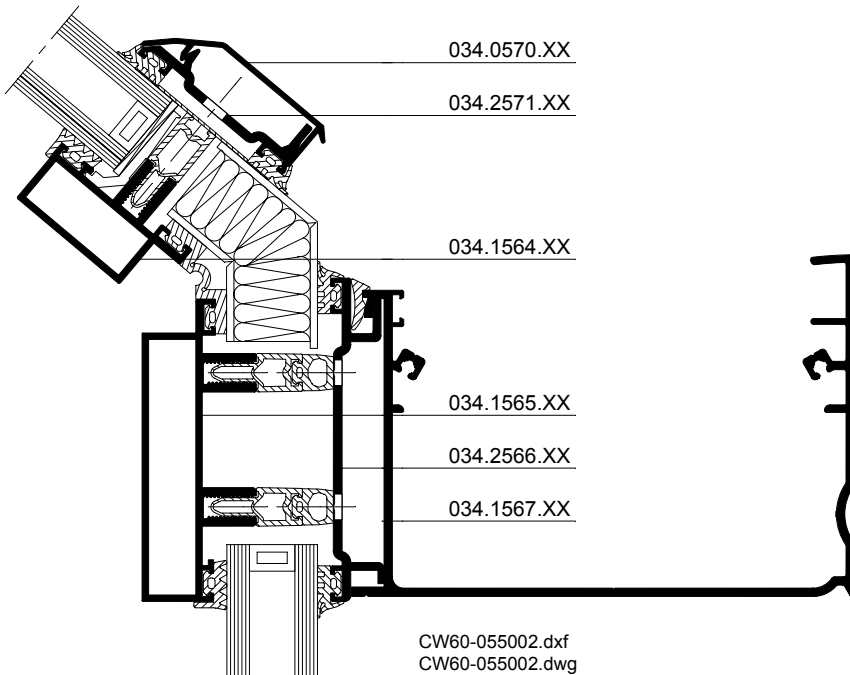

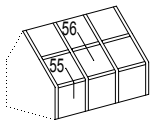

56

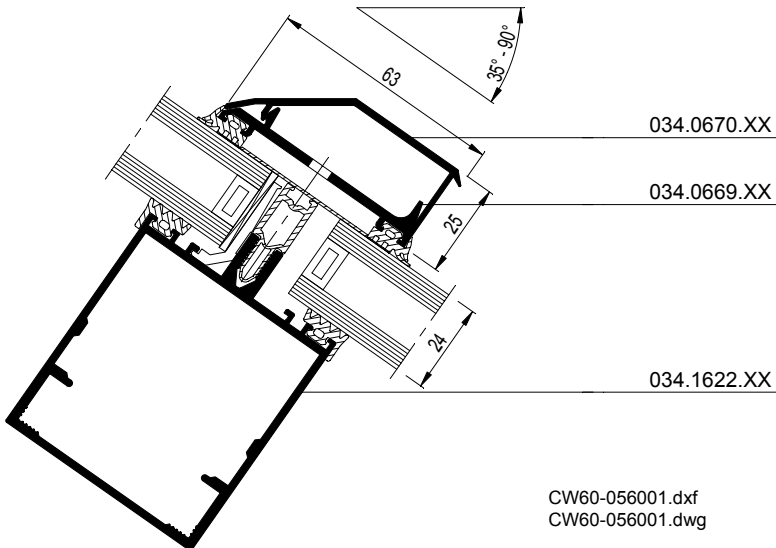

56

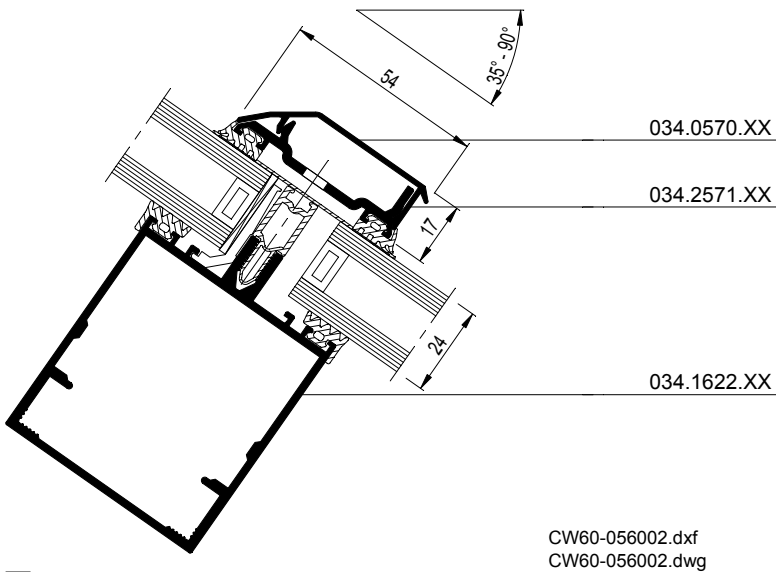

56

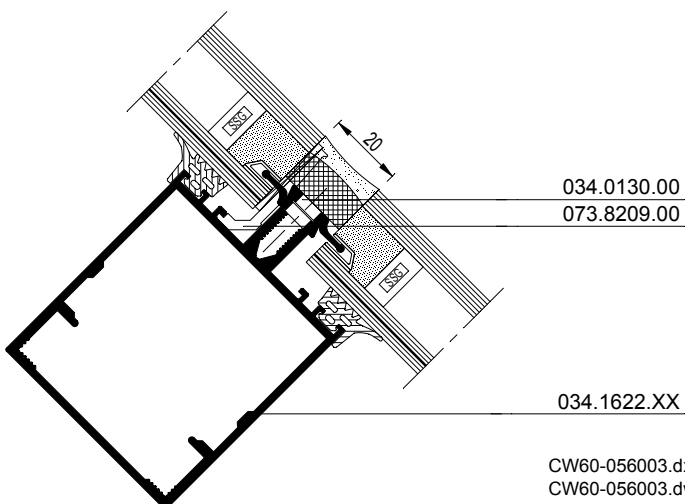

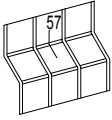

57

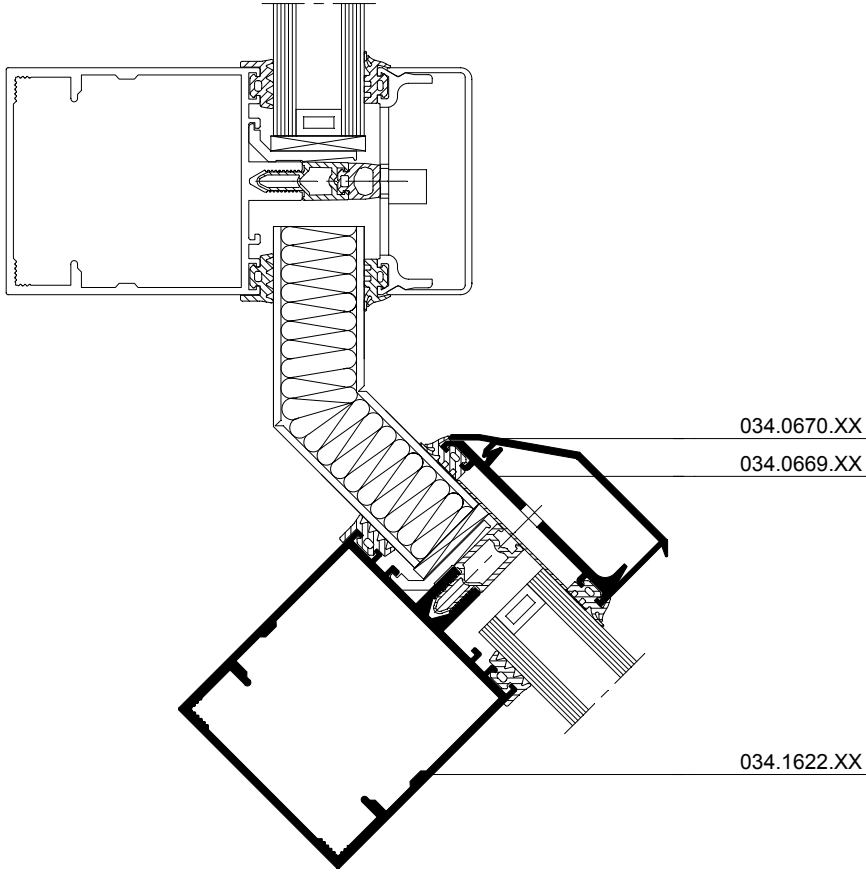

CW60-057001.dxf
CW60-057001.dwg

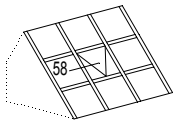

58

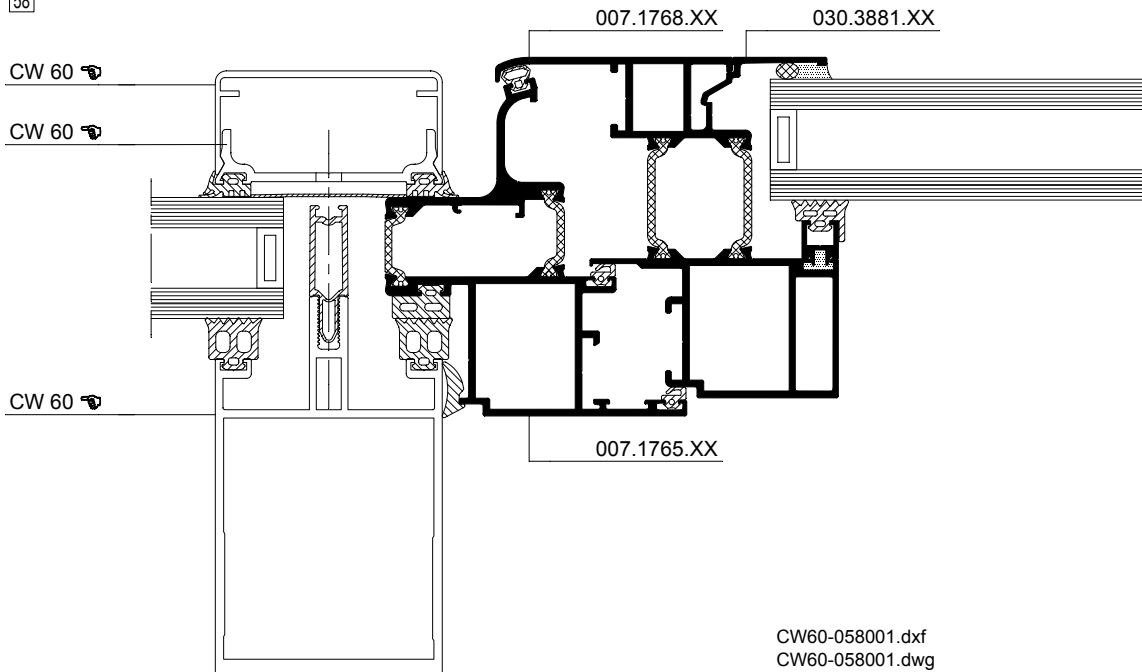

58

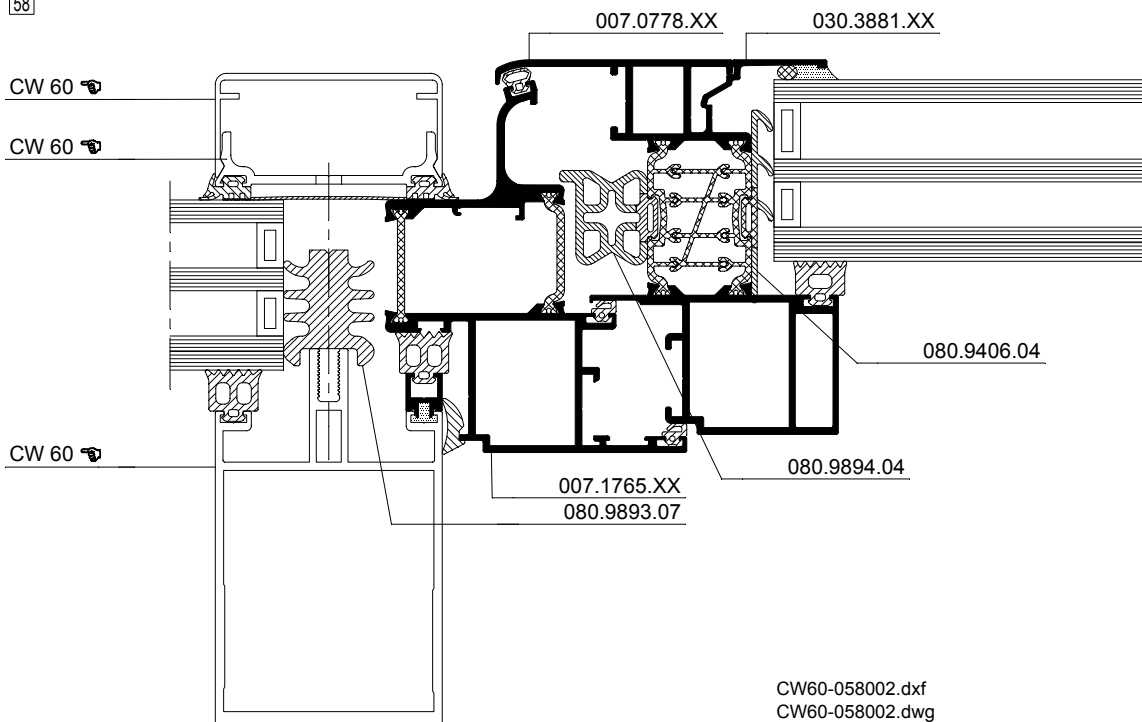

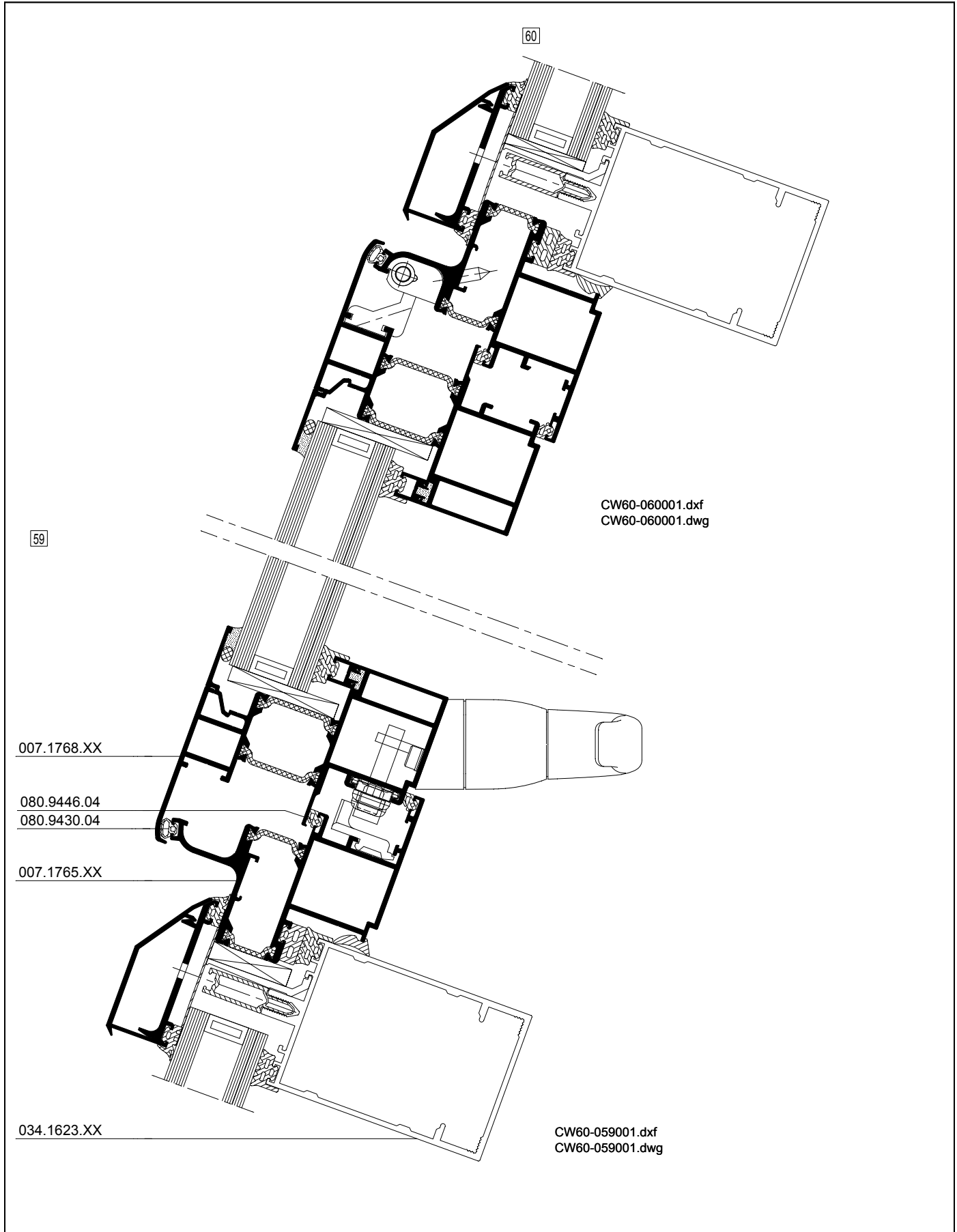
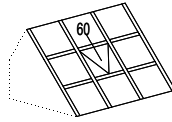
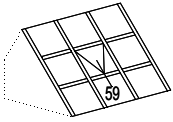

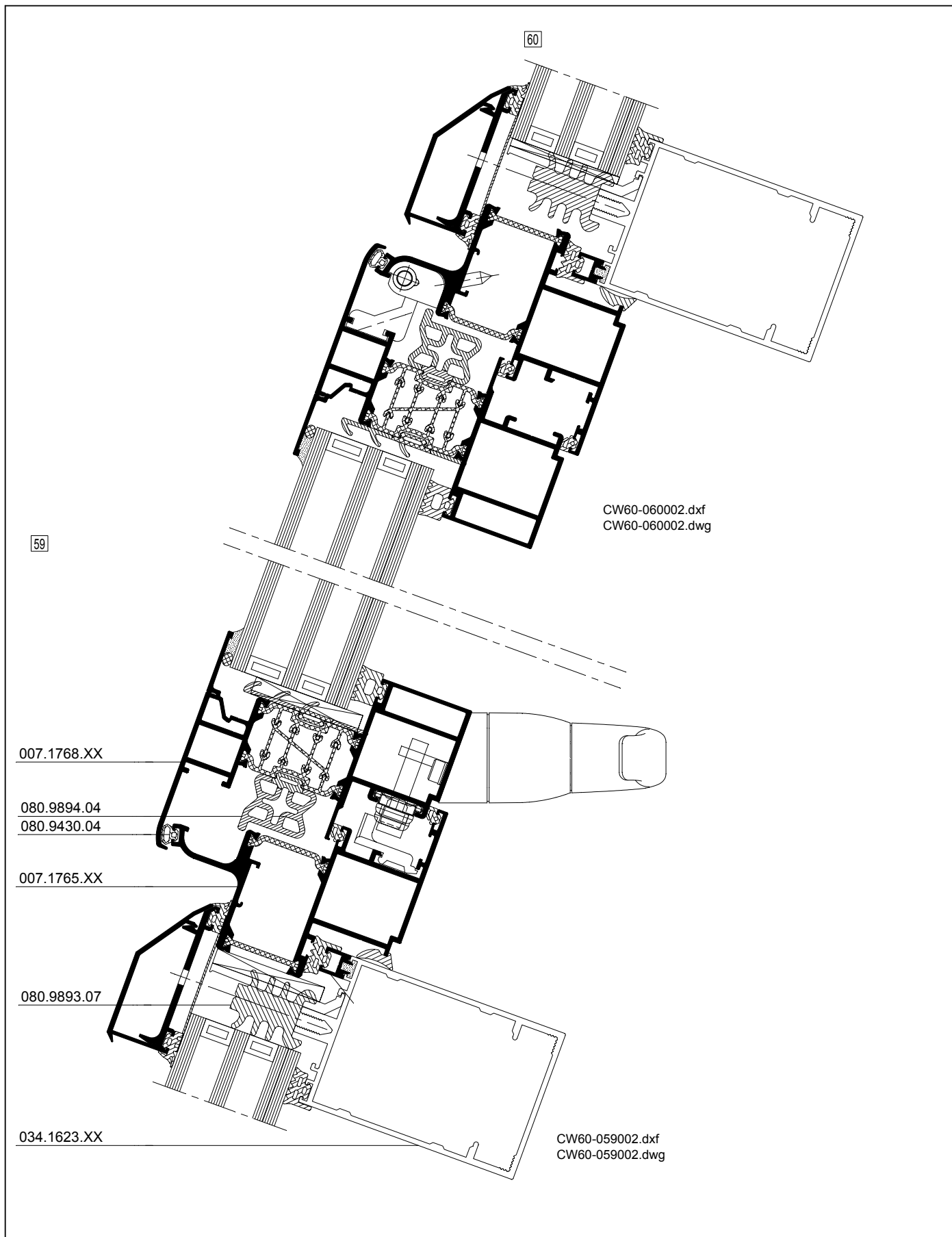
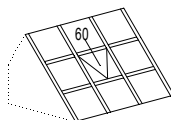
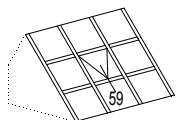

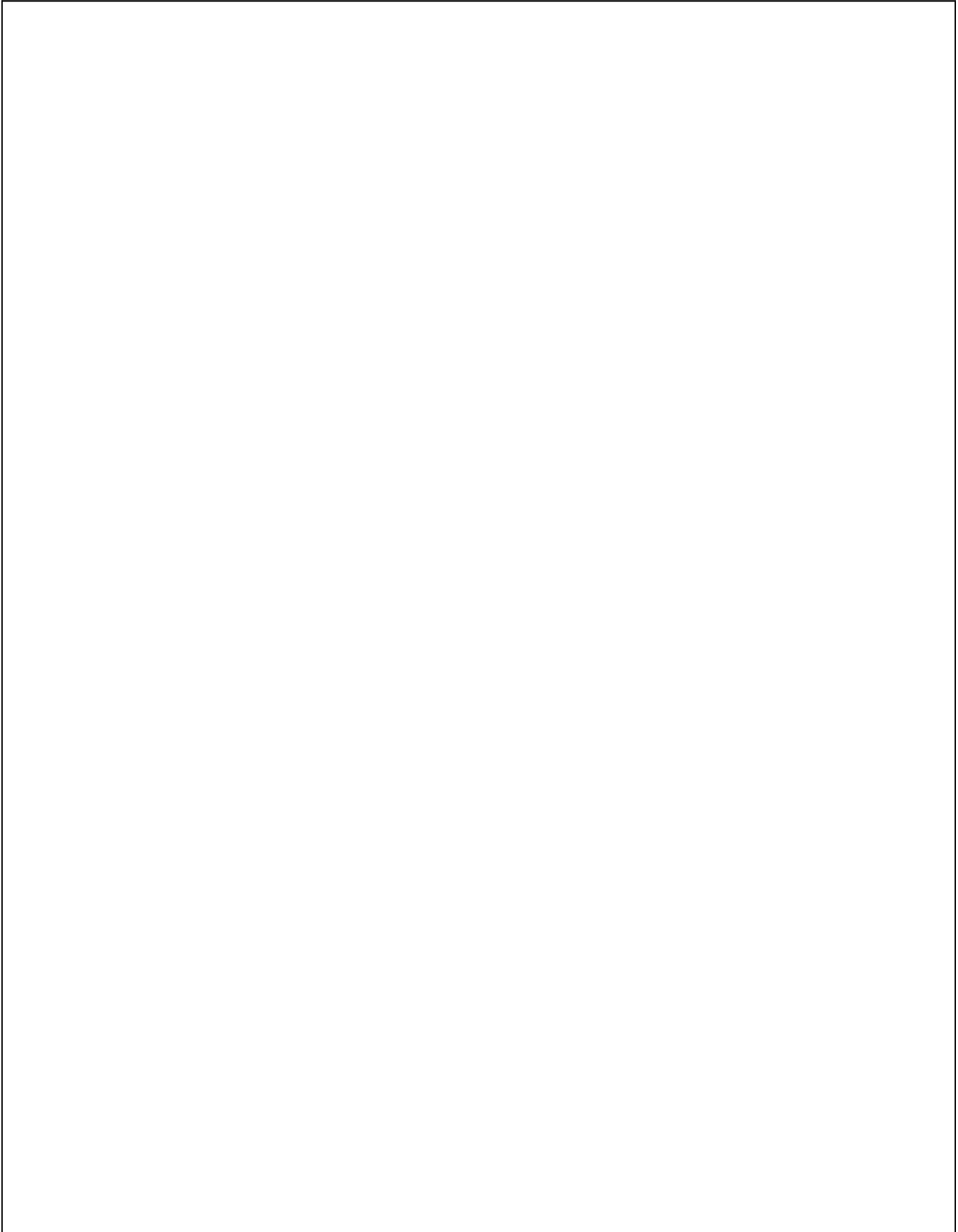

CW 60-HI



1 Internal structure

Vertical internal structure

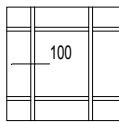

CW 60-HI - 150

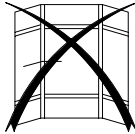
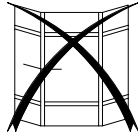

Horizontal internal structure

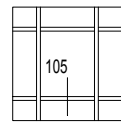

CW 60-HI - 153

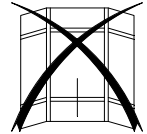
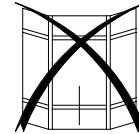

2 External aesthetics

External pressure plate and face cap

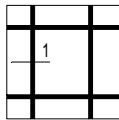

CW 60 - 007

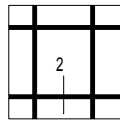

CW 60 - 008

3 Fixed elements

Fixed panels

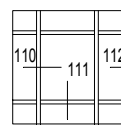
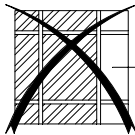
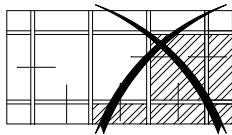

CW 60-HI - 157

4 Junction detail

External aesthetics

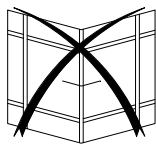
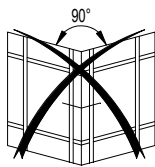

Dilatation

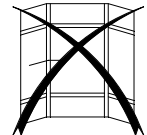
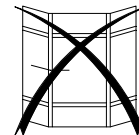
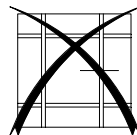

CW 60-HI

Interne structuur - Verticale interne structuur
Structure interne - Structure interne verticale
Internal structure - Vertical internal structure
Interne Struktur - Senkrechte interne Struktur

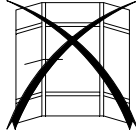
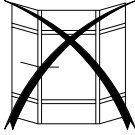
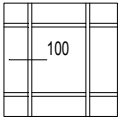

100

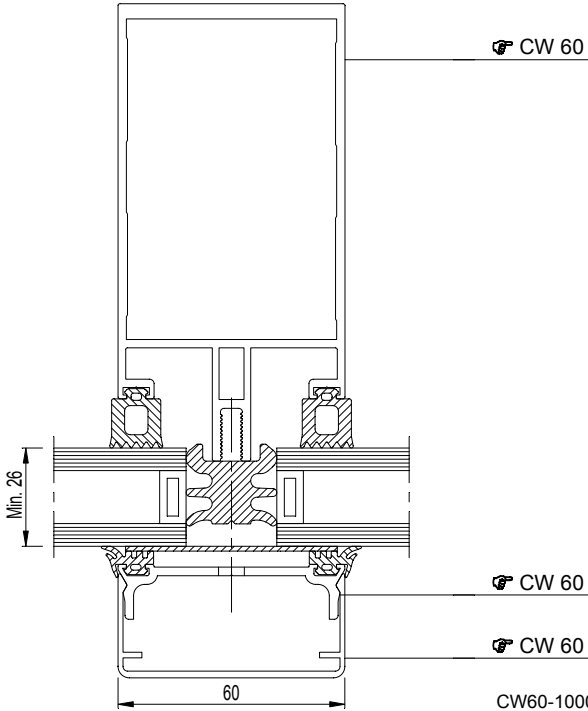

CW60-100001.dxf
CW60-100001.dwg

100

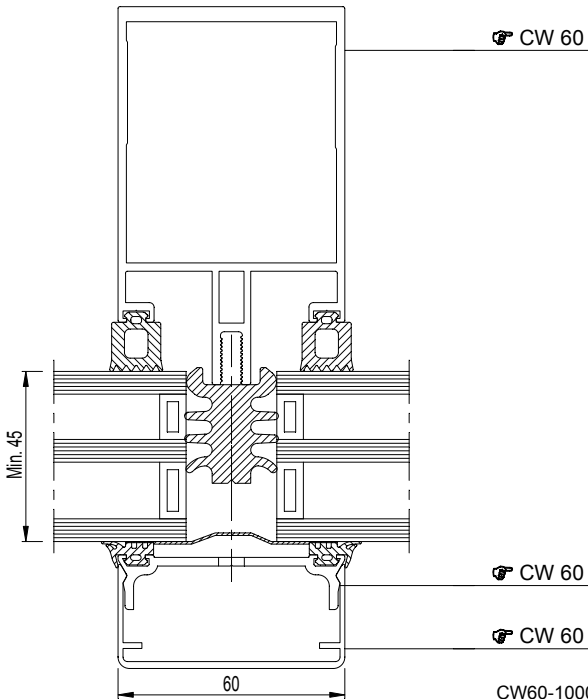

CW60-100002.dxf
CW60-100002.dwg

CW 60-HI

Interne structuur - Horizontale interne structuur
Structure interne - Structure interne horizontale
Internal structure - Horizontal internal structure
Interne Struktur - Horizontale interne Struktur

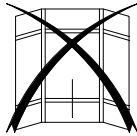
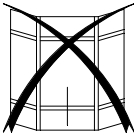
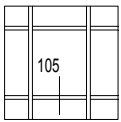

105

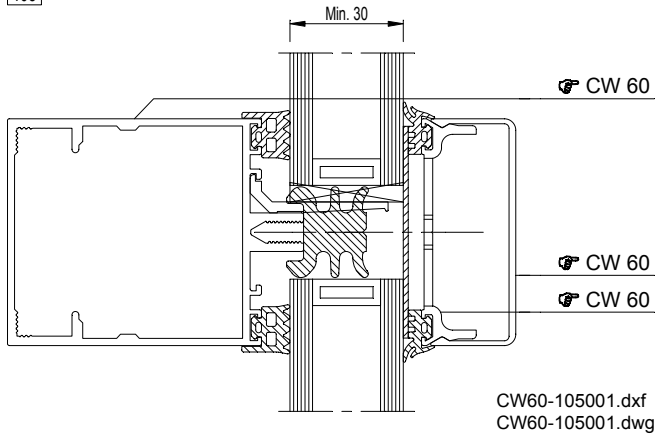

105

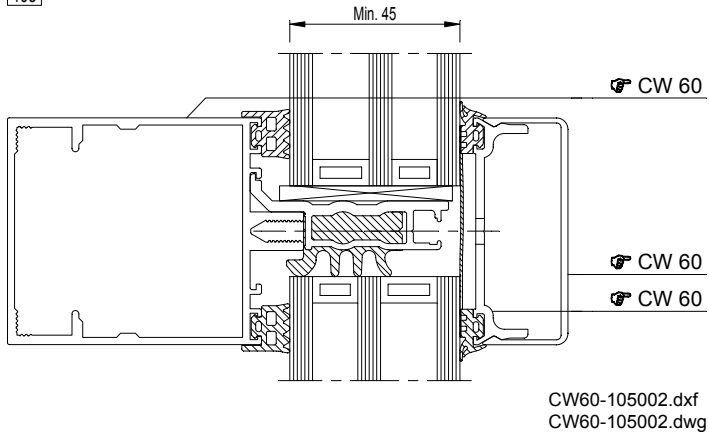

CW 60-HI

Vaste elementen - Vaste panelen
 Eléments fixes - Panneaux fixes
 Fixed elements - Fixed panels
 Feste Elemente - Feste Füllungen



110	111	112

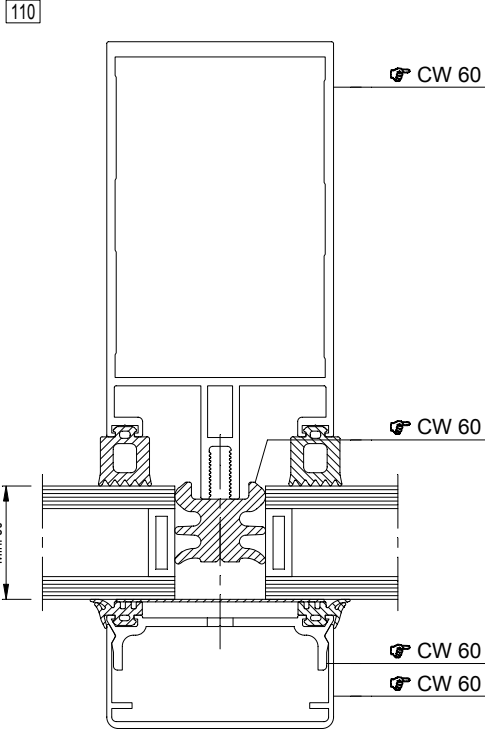

CW60-110001.dxf
 CW60-110001.dwg

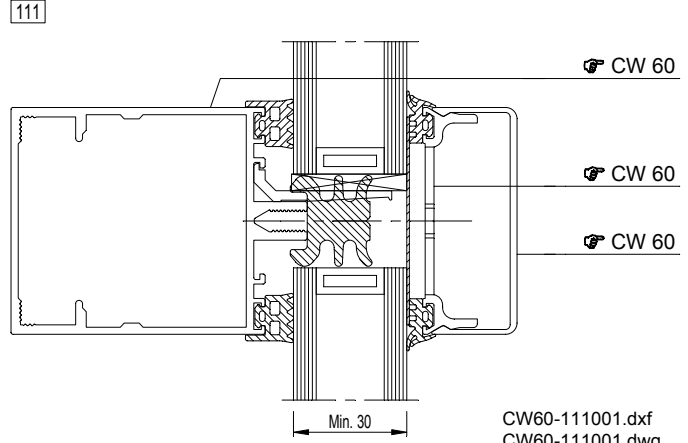

CW60-111001.dxf
 CW60-111001.dwg

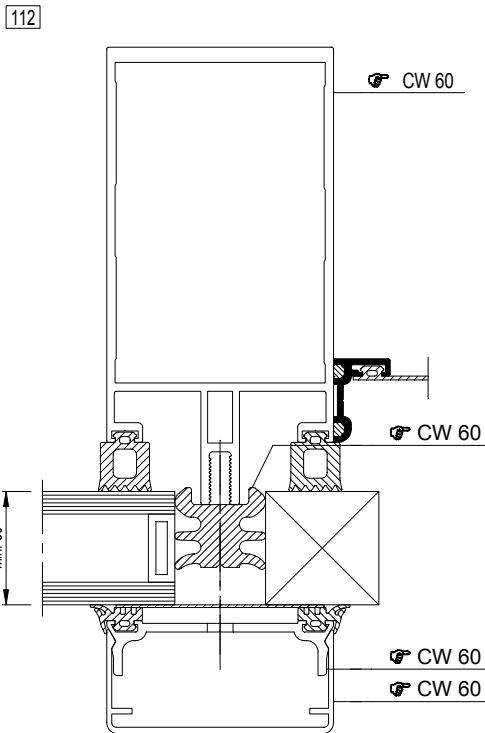

CW60-112001.dxf
 CW60-112001.dwg

CW 60 Horizontal Lining



1 Internal structure

Vertical internal structure

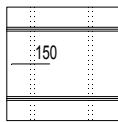

CW 60-HL - 200

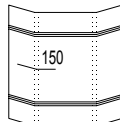

CW 60-HL - 200

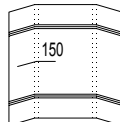

CW 60-HL - 200

Horizontal internal structure

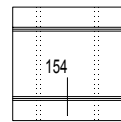

CW 60-HL - 201

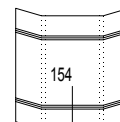

CW 60-HL - 201

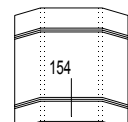

CW 60-HL - 201

2 External aesthetics

External pressure plate and face cap

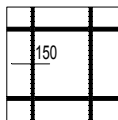

CW 60-HL - 202

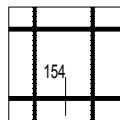

CW 60-HL - 202

3 Fixed elements CW 60

Fixed panels

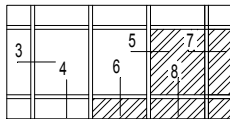

CW 60 - 010

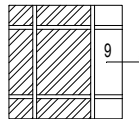

CW 60 - 011

4 Opening elements

Windows with structural vent

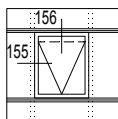

CW 60-HL - 204

5 Junction detail CW 60

Angle solutions

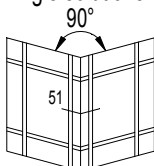

CW 60 - 030

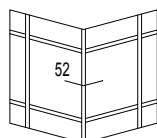

CW 60 - 032

Dilatation

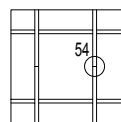

CW 60 - 034

CW 60-HL

Interne structuur - Verticale interne structuur
Structure interne - Structure interne verticale
Internal structure - Vertical internal structure
Interne Struktur - Senkrechte interne Struktur

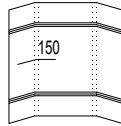
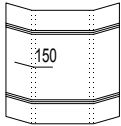
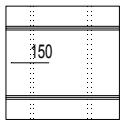

150

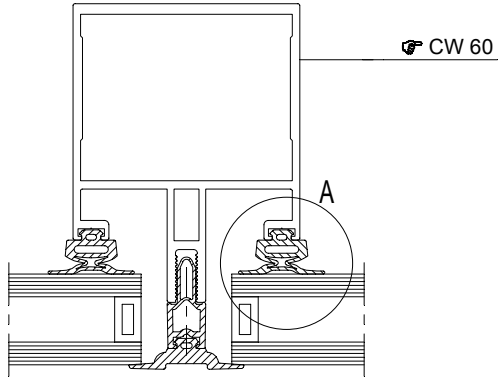

CW60-150001.dxf
CW60-150001.dwg

MIN. 160°

A

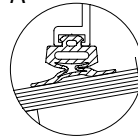

CW60-150002.dxf
CW60-150002.dwg

MIN. 200°

A

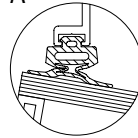

CW60-150003.dxf
CW60-150003.dwg

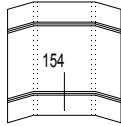
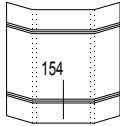
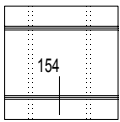

154

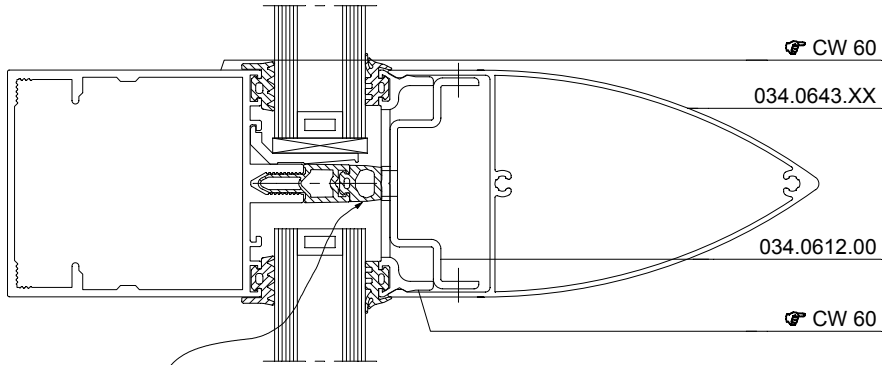

Horizontale compartimentering is verplicht
Compartmentation horizontale est obligatoire
Horizontal compartmentalisation is obligatory
Horizontale Kompartimentierung ist verpflichtet

CW60-154001.dxf
CW60-154001.dwg

CW 60-HL

Esthetiek - buiten - Klemprofiel en afdekprofiel - buiten
Esthétique extérieure - Serreur et capot - extérieur
External aesthetics - External pressure plate and face cap
Ästhetik - außen - Glashalteprofil und Abdeckprofil - außen

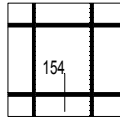
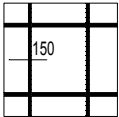

150

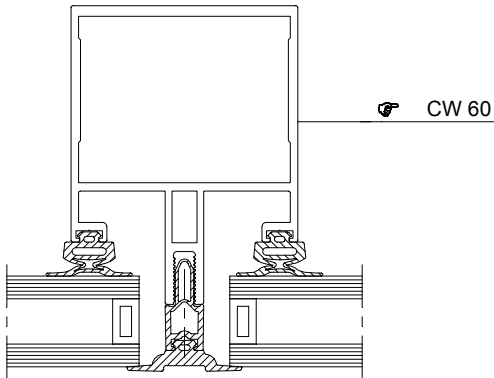

CW60-150001.dxf
CW60-150001.dwg

154

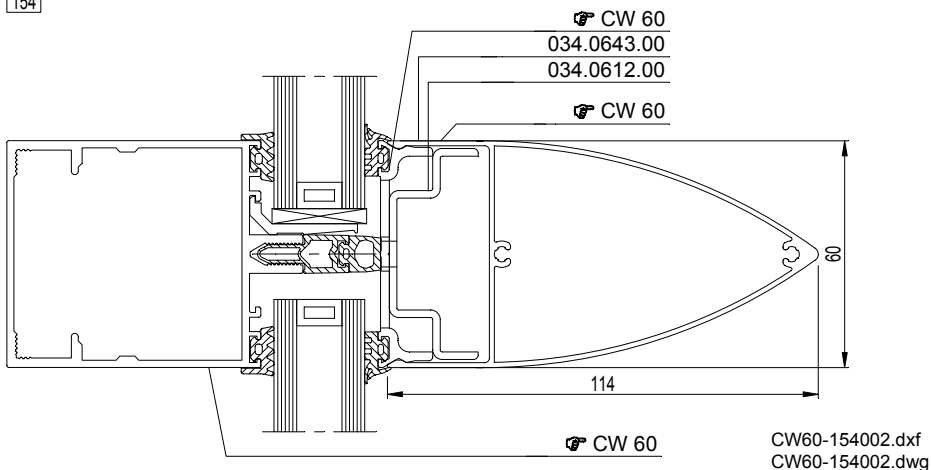

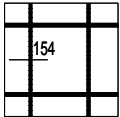

154

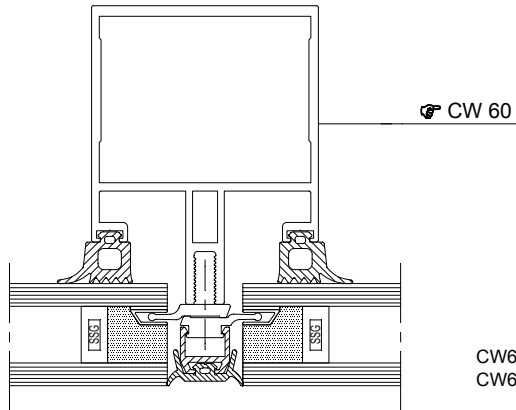

CW60-154003.dxf
CW60-154003.dwg

154

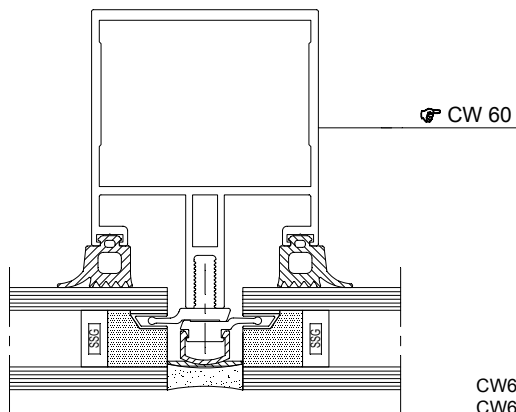

CW60-154004.dxf
CW60-154004.dwg

154

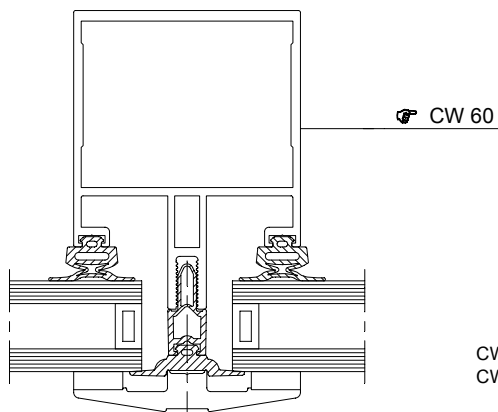

CW60-154005.dxf
CW60-154005.dwg

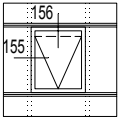

155

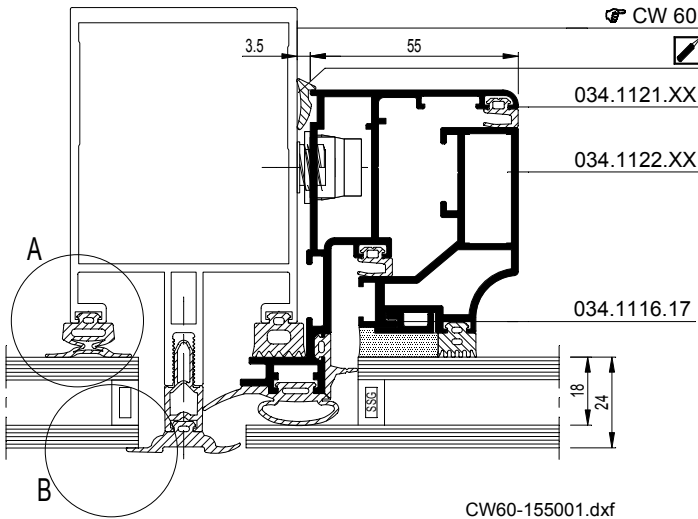

CW60-155001.dxf
 CW60-155001.dwg

CW 60

MIN. 170°

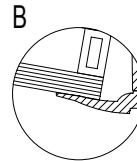
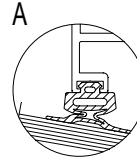

CW60-155002.dxf
 CW60-155002.dwg

MIN. 190°

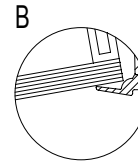
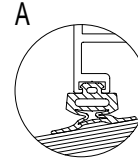

CW60-155003.dxf
 CW60-155003.dwg

156

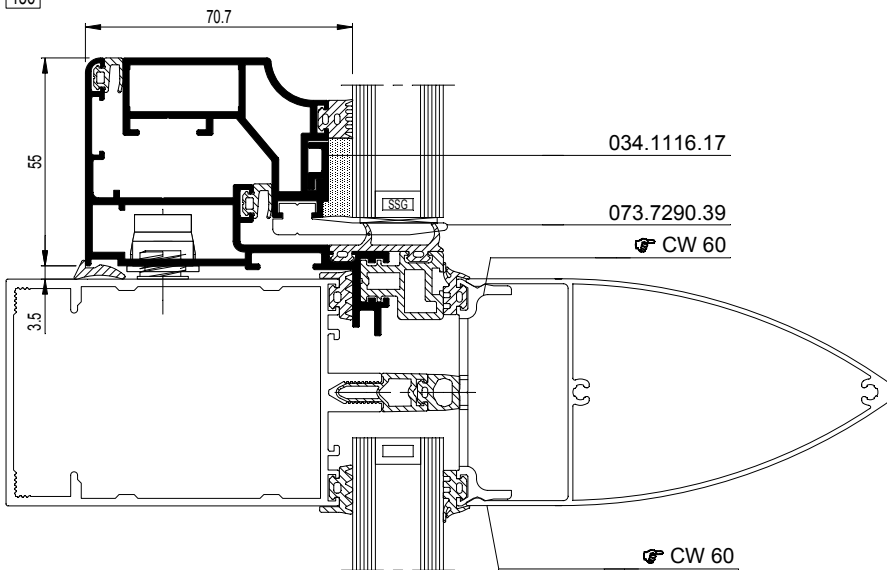

CW60-156001.dxf
 CW60-156001.dwg

CW 60



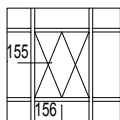

155

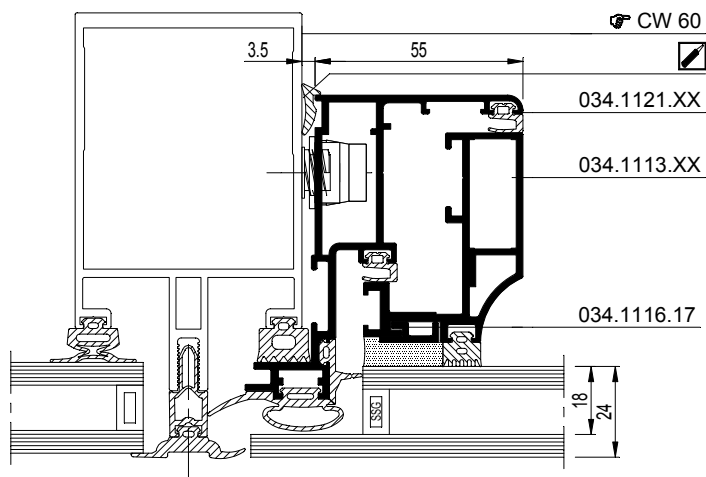

CW60-155004.dxf
 CW60-155004.dwg

156

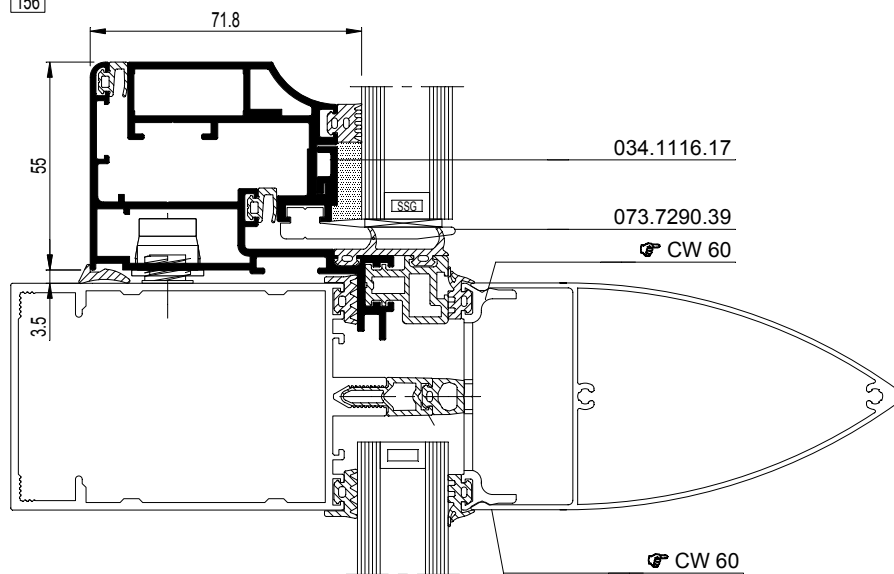

CW60-156002.dxf
 CW60-156002.dwg



CW 60-HL

Opengaaende elementen - Ramen met structurele vleugels
Éléments ouvrants - Fenêtres avec ouvrants VEC
Opening elements - Windows with structural vent
Öffnende Elemente - Fenster mit strukturellen Flügeln

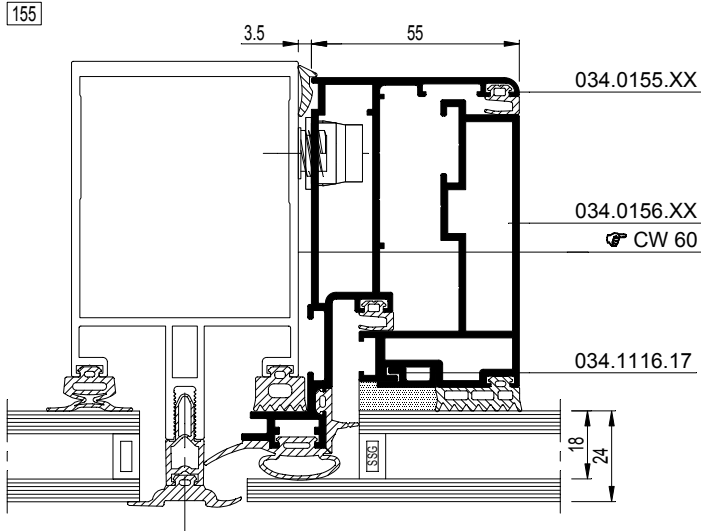
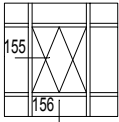

CW60-155005.dxf
CW60-155005.dwg

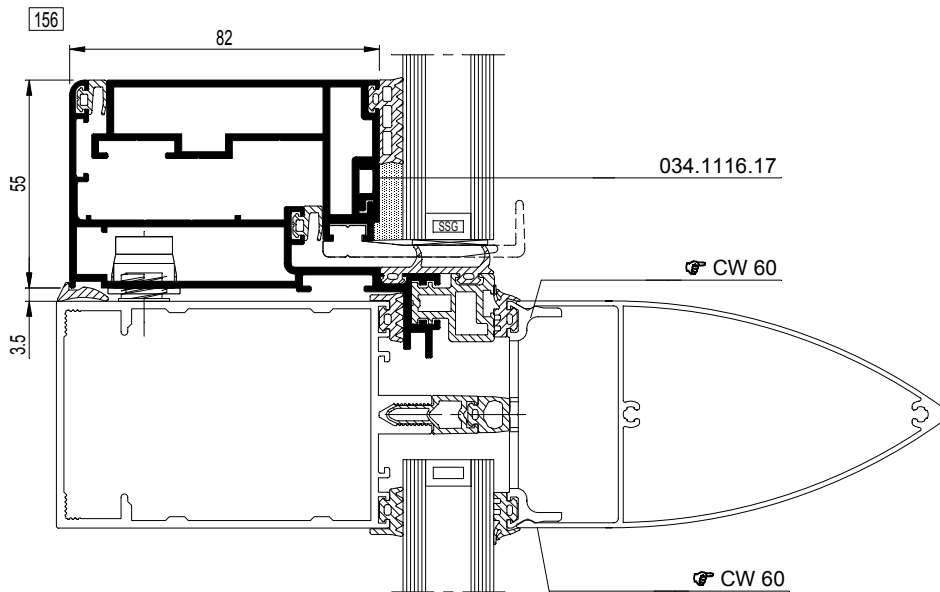

CW60-156003.dxf
CW60-156003.dwg



CW 60 Structural Clamped



1 Internal structure

Vertical internal structure

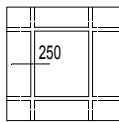

CW 60-SC - 252

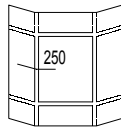

CW 60-SC - 252

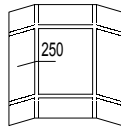

CW 60-SC - 252

Horizontal internal structure

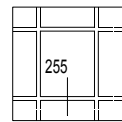

CW 60-SC - 254

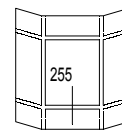

CW 60-SC - 254

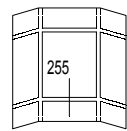

CW 60-SC - 254

2 Fixed elements

Fixed panels

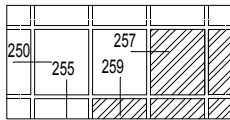

CW 60-SC - 255

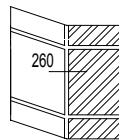

CW 60-SC - 257

3 Opening elements

Windows with Structural Vent

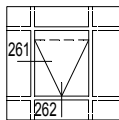

CW 60-SC - 258

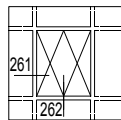

CW 60-SC - 259

4 Junction detail

Angle solutions

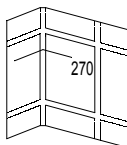

CW 60-SC - 265

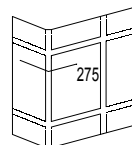

CW 60-SC - 267

Dilatation

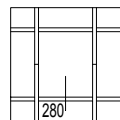

CW 60-SC - 269

CW 60-SC

Interne structuur - Verticale interne structuur
 Structure interne - Structure interne verticale
 Internal structure - Vertical internal structure
 Interne Struktur - Senkrechte interne Struktur

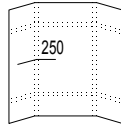
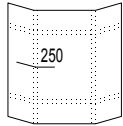
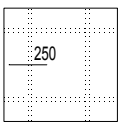

250

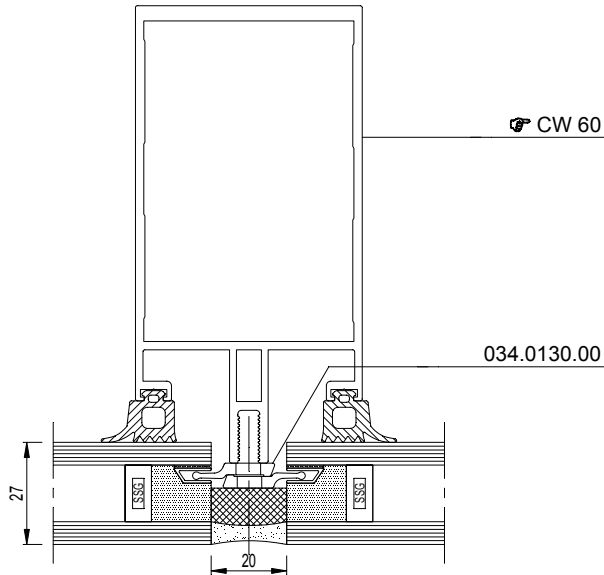

CW60-250001.dxf
 CW60-250001.dwg

VARIANTE

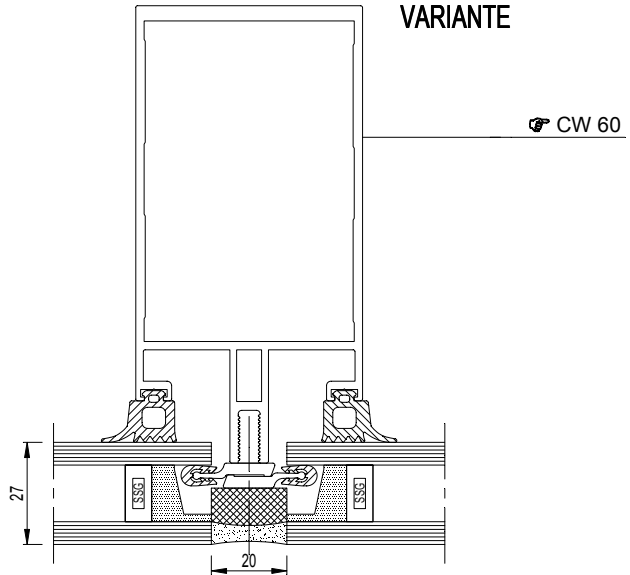

CW60-250003.dxf
 CW60-250003.dwg

250

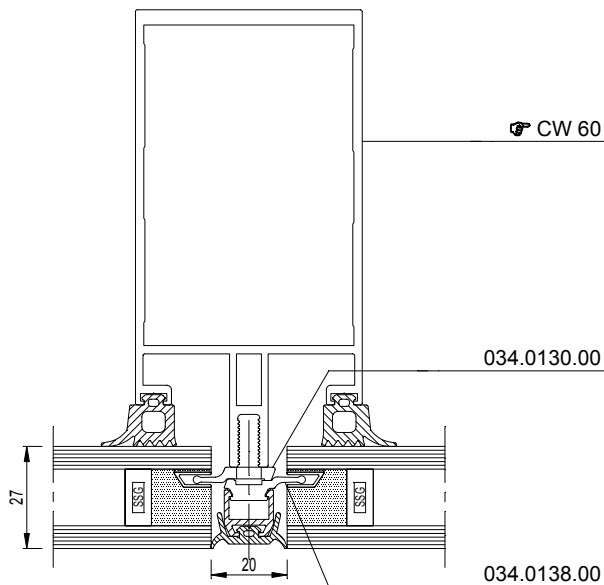

CW60-250002.dxf
 CW60-250002.dwg

VARIANTE

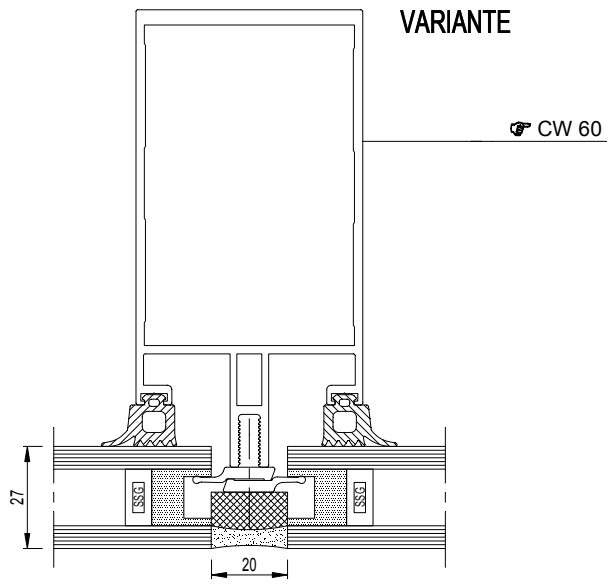

CW60-250004.dxf
 CW60-250004.dwg



CW 60-SC

Interne structuur - Verticale interne structuur
Structure interne - Structure interne verticale
Internal structure - Vertical internal structure
Interne Struktur - Senkrechte interne Struktur

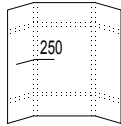
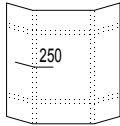
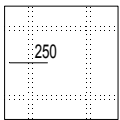

250

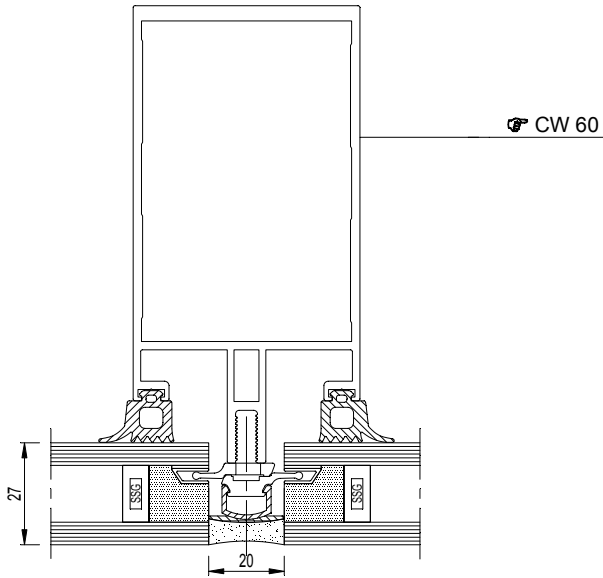

CW60-250005.dxf
CW60-250005.dwg

250

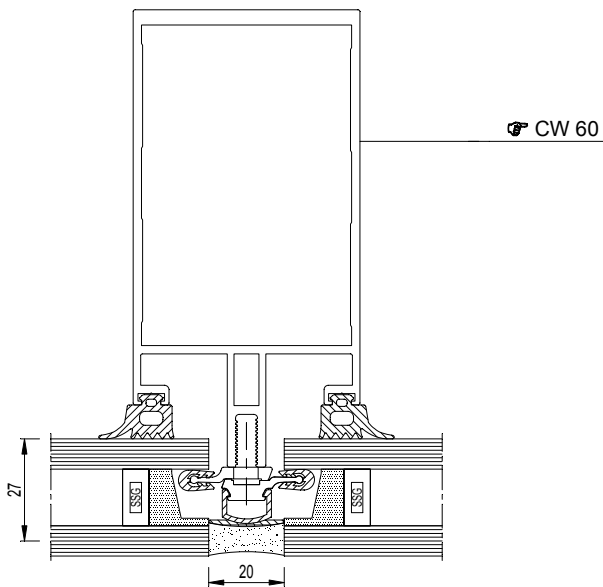

CW60-250006.dxf
CW60-250006.dwg



CW 60-SC

Structuur - Horizontale interne structuur
 Structure interne - Structure interne horizontale
 Internal structure - Horizontal internal structure
 Interne Struktur - Horizontale interne Struktur

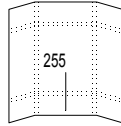
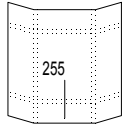
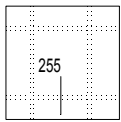

255

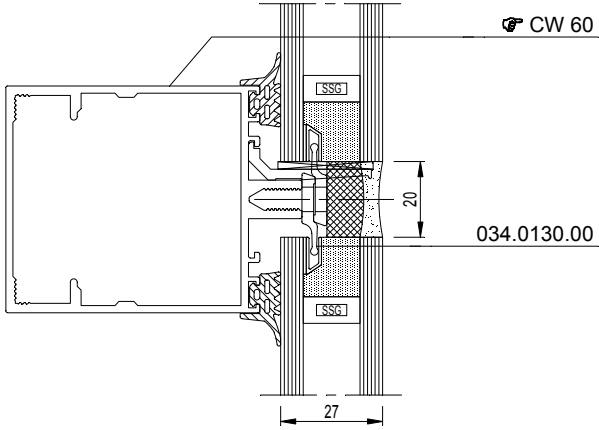

CW60-255001.dxf
 CW60-255001.dwg

255

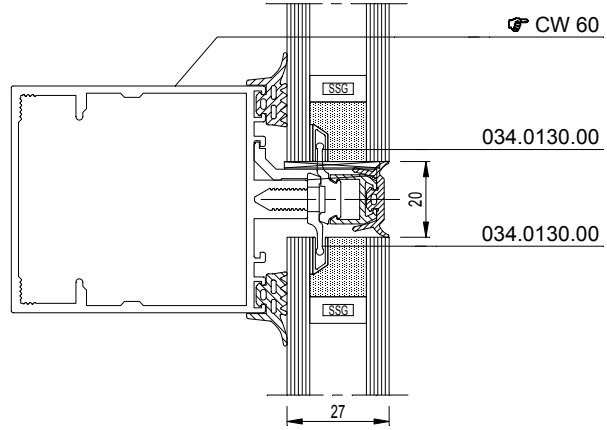

CW60-255002.dxf
 CW60-255002.dwg

255

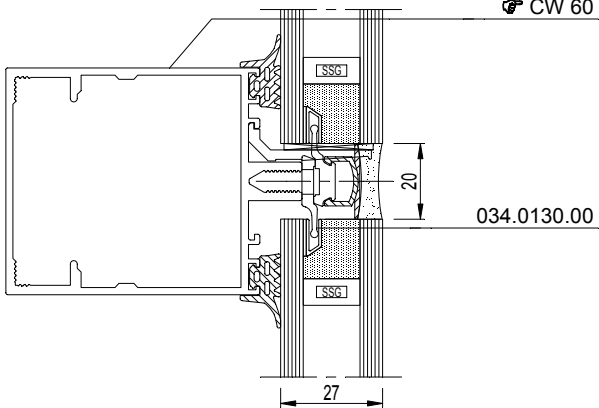

CW60-255003.dxf
 CW60-255003.dwg

255

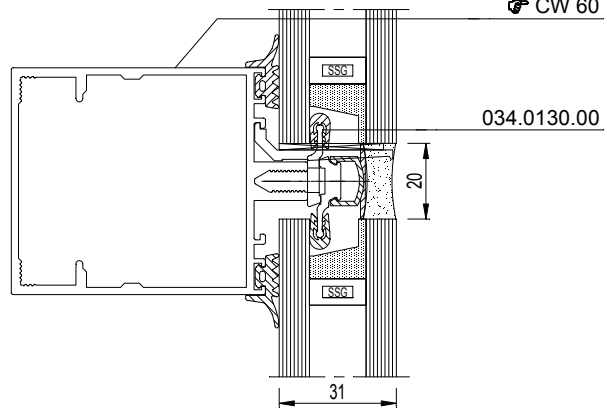

CW60-255004.dxf
 CW60-255004.dwg

255

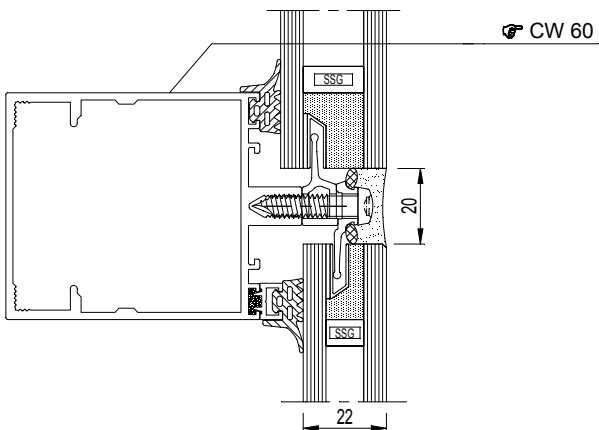

CW60-255005.dxf
 CW60-255005.dwg



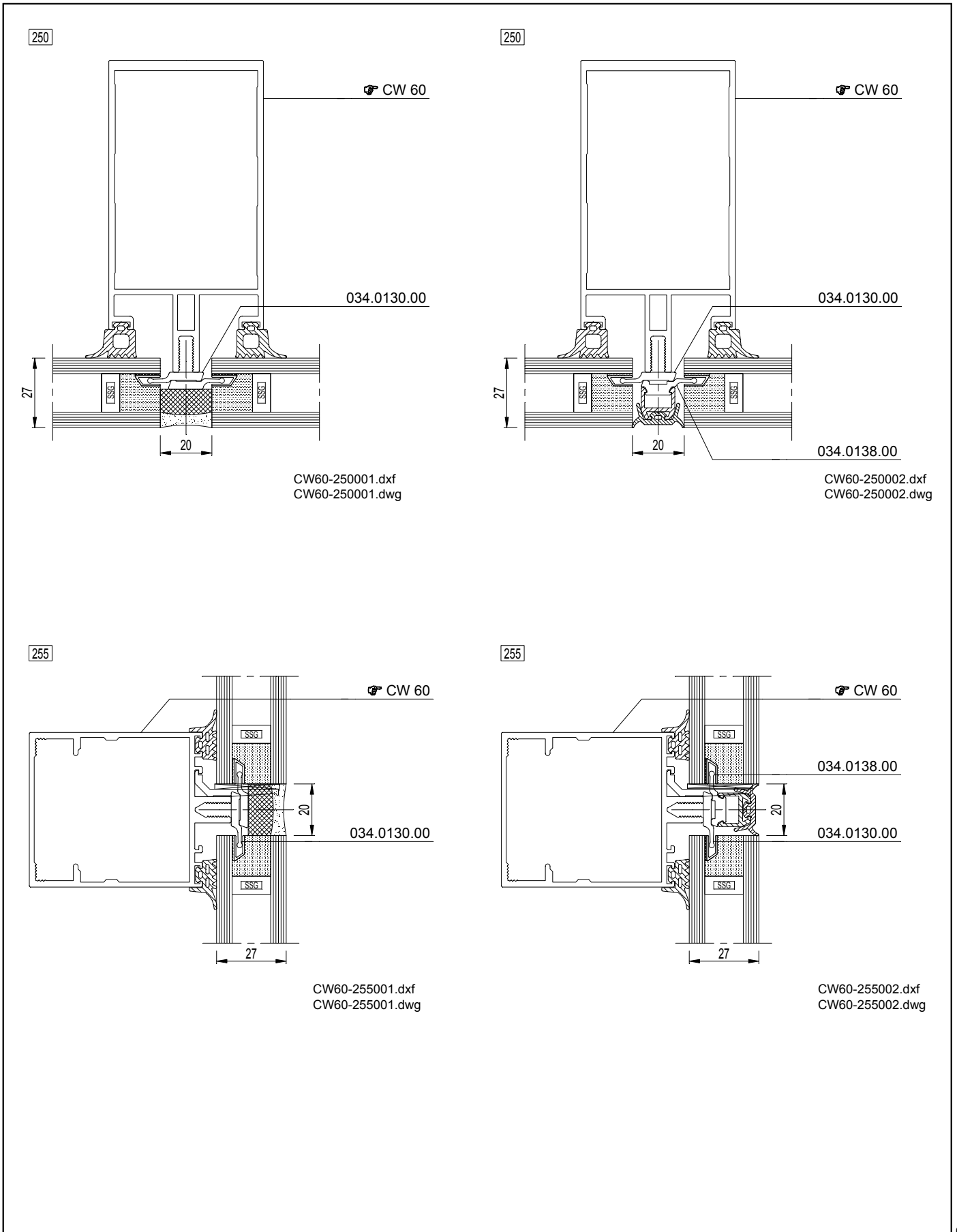
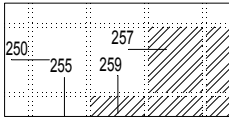

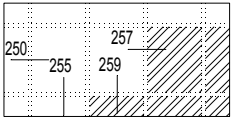

257

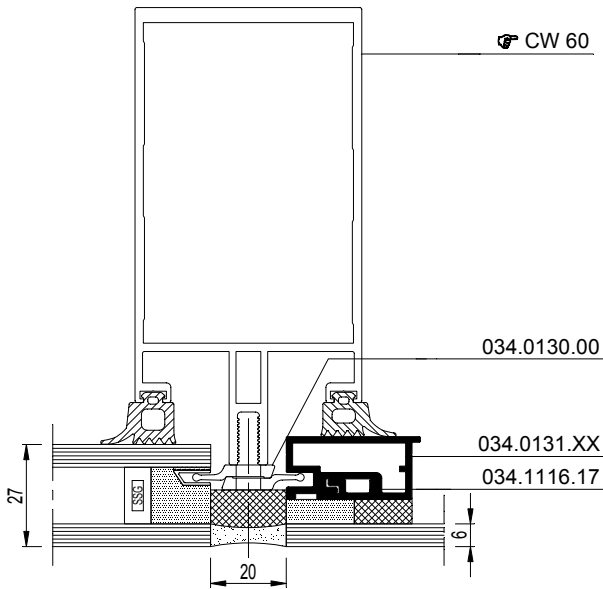

CW60-257001.dxf
 CW60-257001.dwg

257

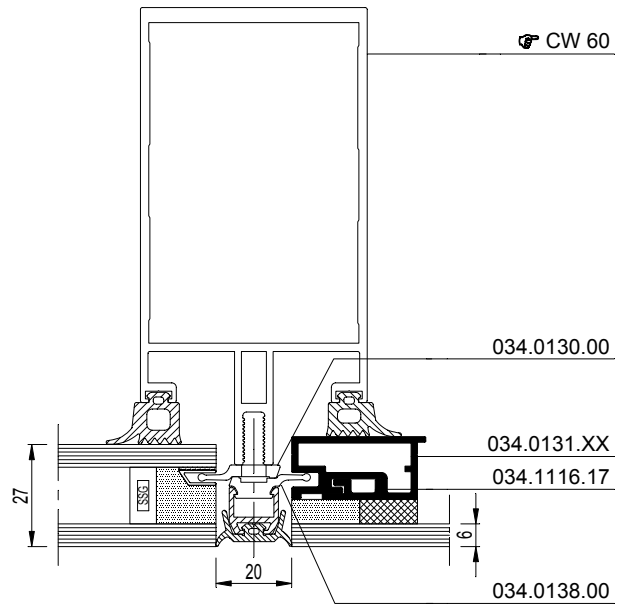

CW60-257002.dxf
 CW60-257002.dwg

259

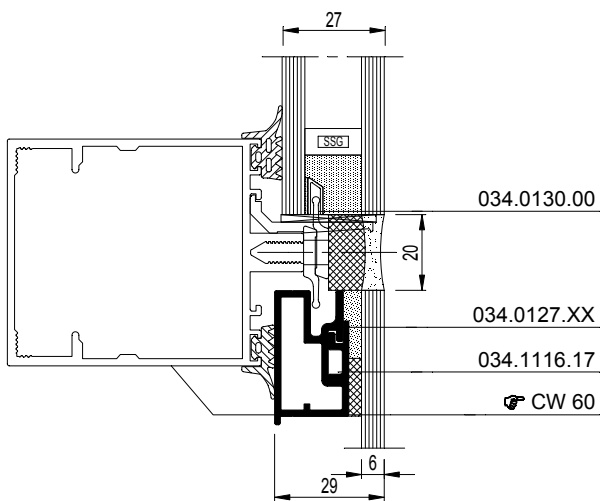

CW60-259001.dxf
 CW60-259001.dwg

259

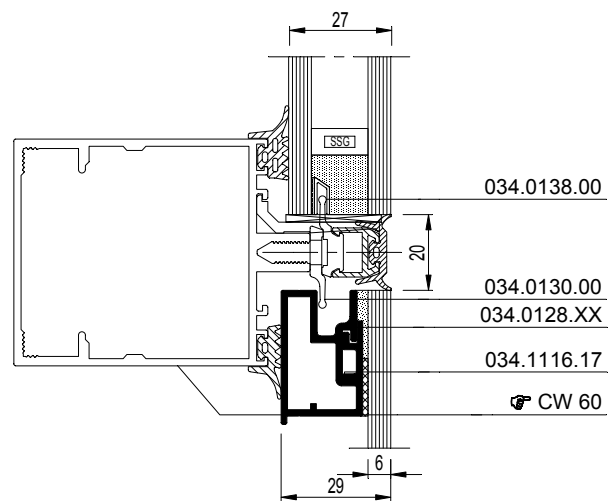

CW60-259002.dxf
 CW60-259002.dwg



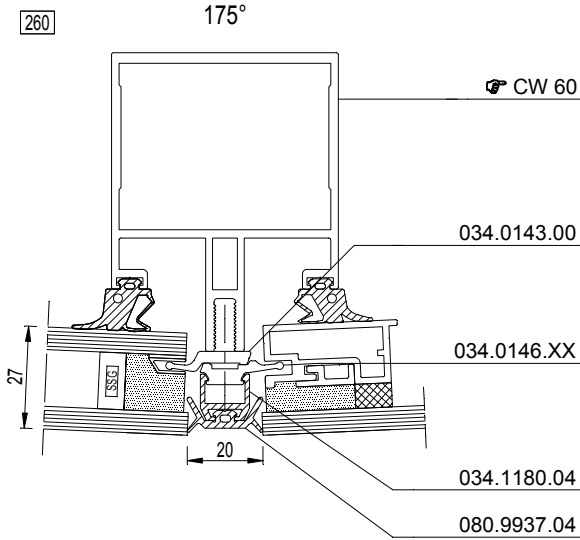
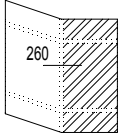

CW60-260001.dxf
 CW60-260001.dwg

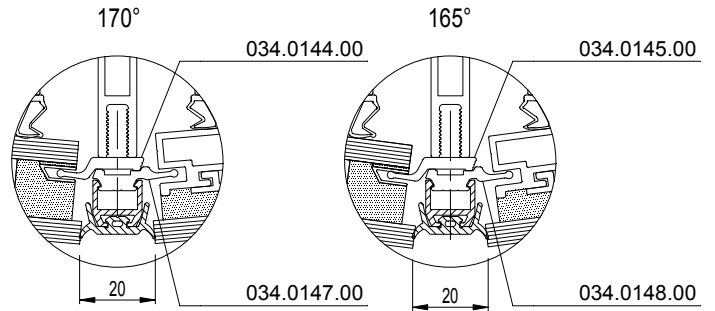

CW60-260002.dxf
 CW60-260002.dwg

CW60-260003.dxf
 CW60-260003.dwg

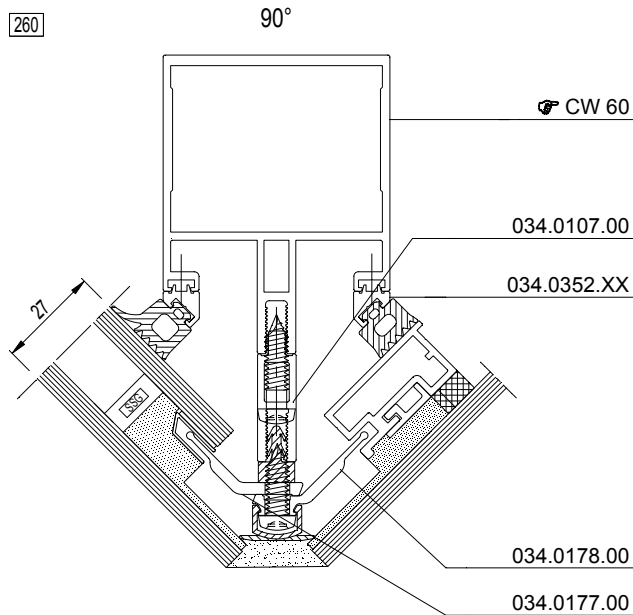

CW60-260004.dxf
 CW60-260004.dwg

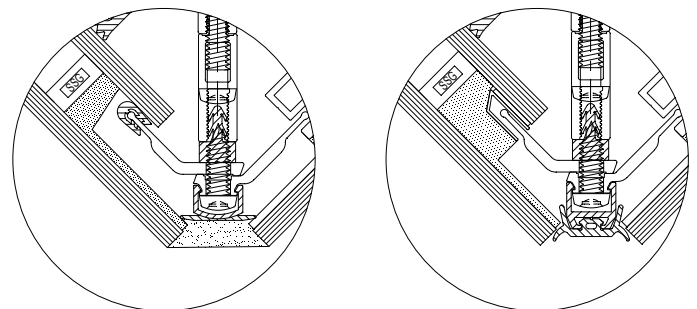

CW60-260005.dxf
 CW60-260005.dwg

CW60-260006.dxf
 CW60-260006.dwg



CW 60-SC

Opengaande elementen - Ramen met structurele vleugels
Éléments ouvrants - Fenêtres avec ouvrants VEC
Opening elements - Windows with structural vent
Öffnende Elemente - Fenster mit strukturellen Flügeln

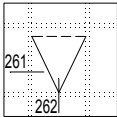

261

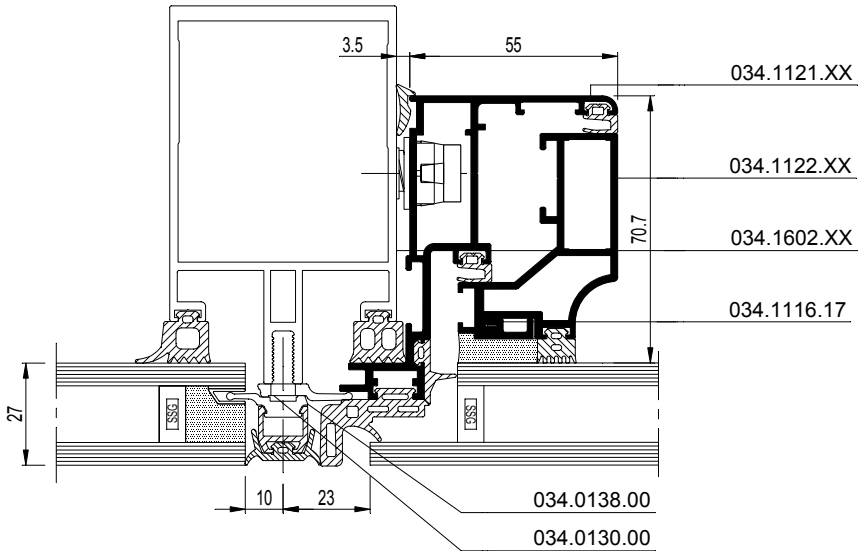

CW60-261001.dxf
CW60-261001.dwg

262

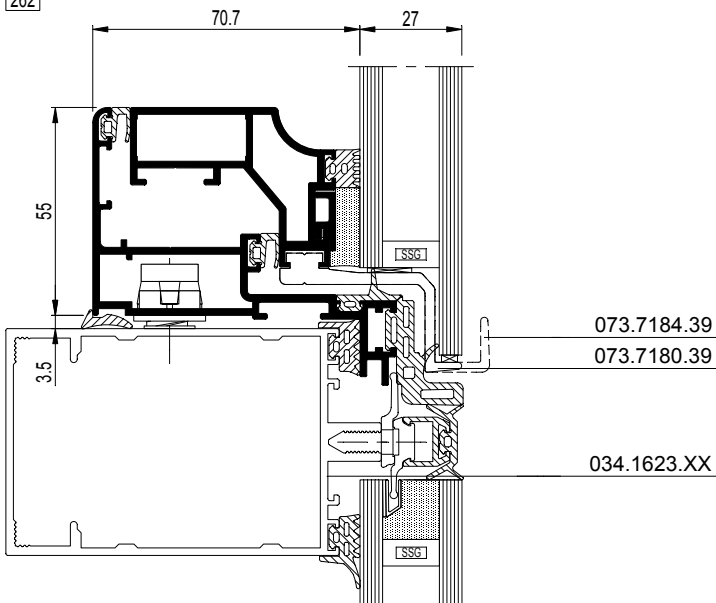

CW60-262001.dxf
CW60-262001.dwg



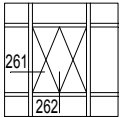

261

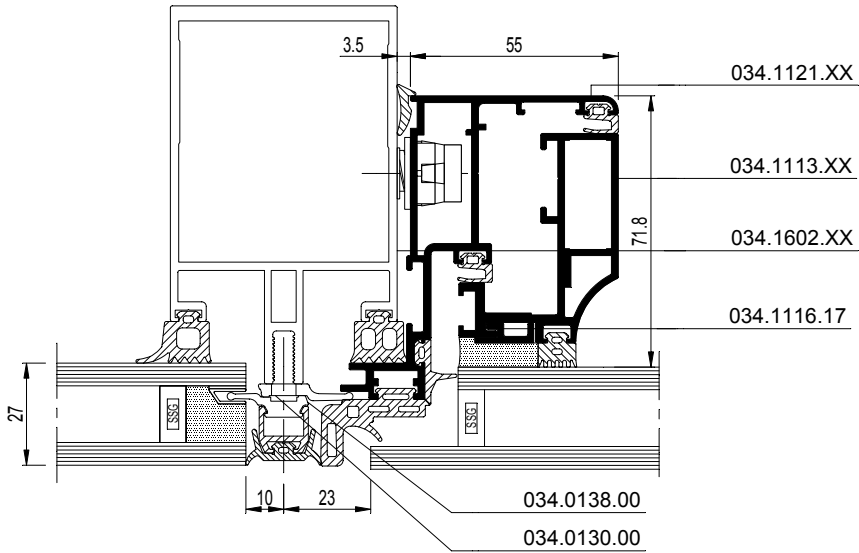

CW60-261002.dxf
 CW60-261002.dwg

262

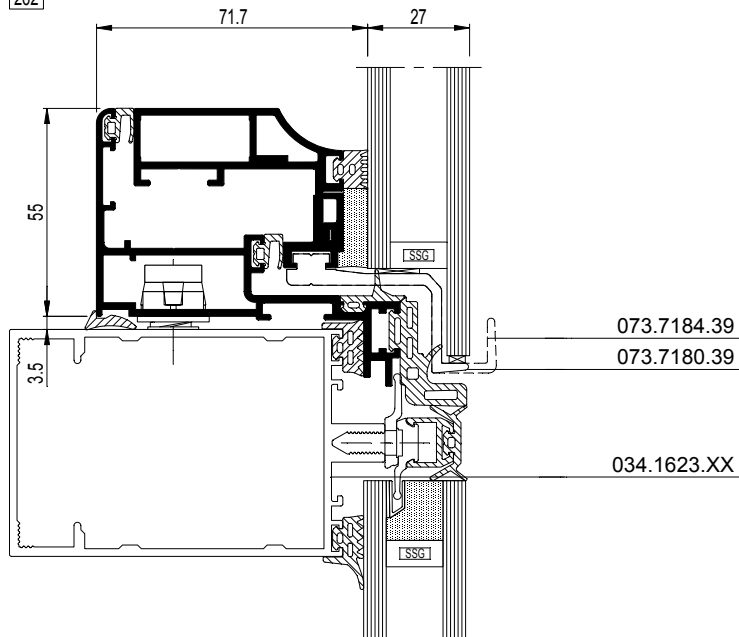

CW60-262002.dxf
 CW60-262002.dwg



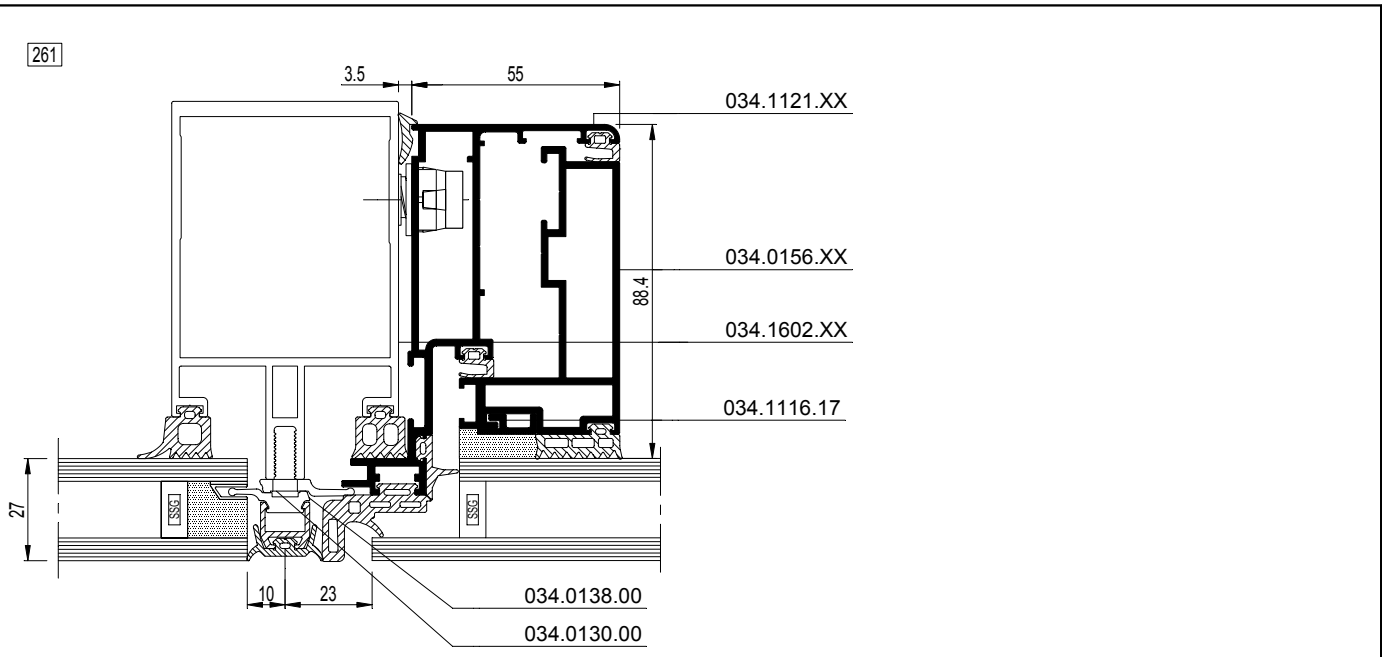
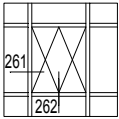

CW60-261003.dxf
 CW60-261003.dwg

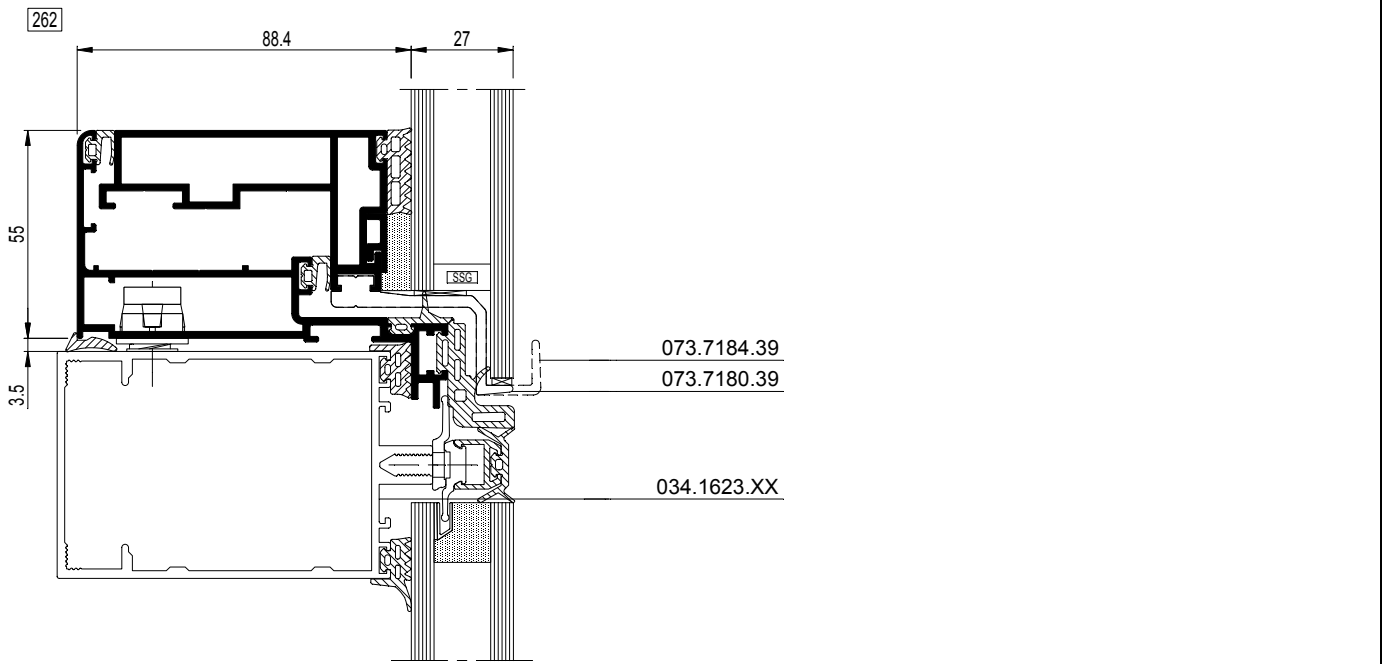

CW60-262003.dxf
 CW60-262003.dwg



CW 60-SC

Aansluitingen - Hoekoplossingen
Raccordements - Solutions d'angle
Junction detail - Angle solutions
Anschlüsse - Winkellösungen

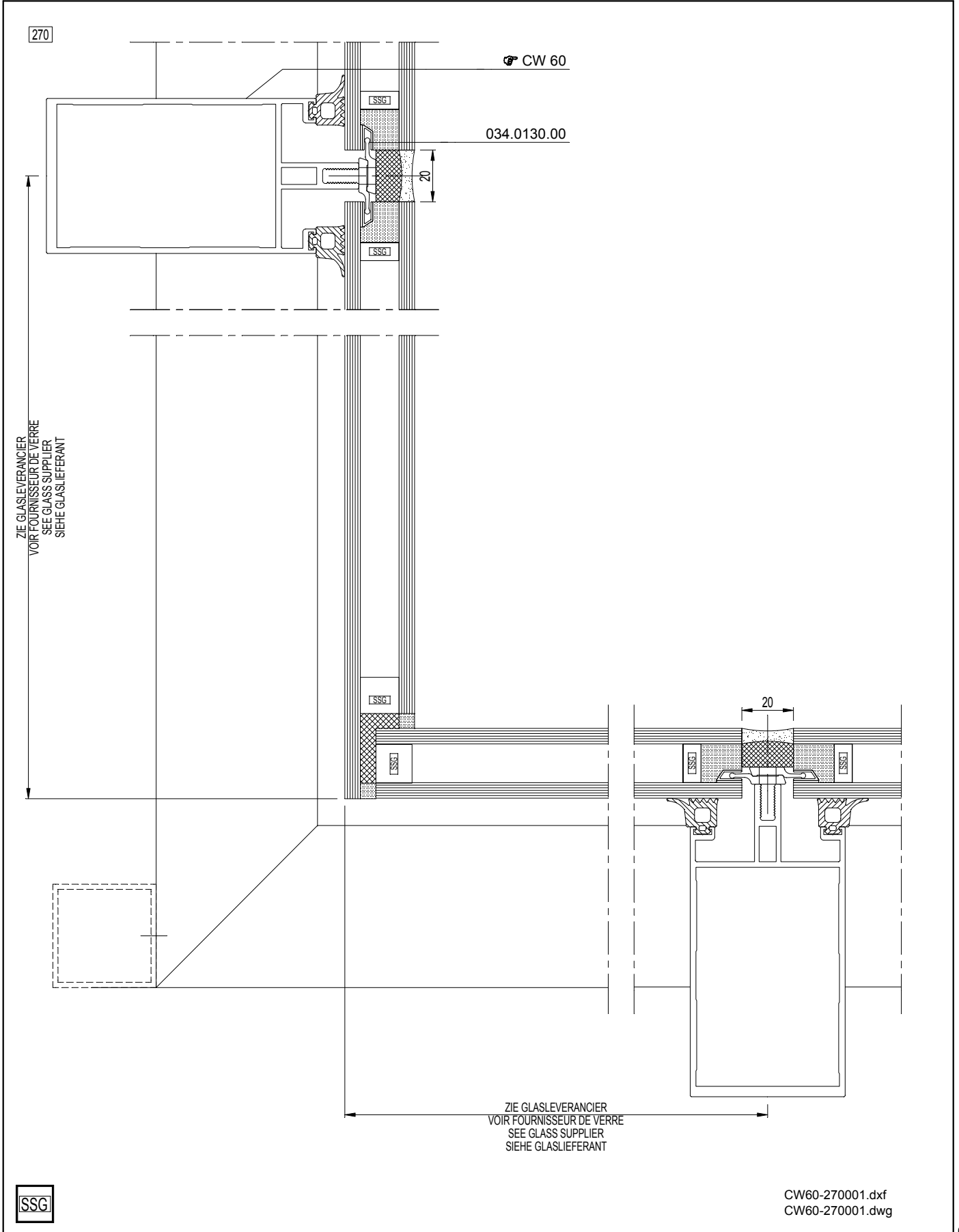
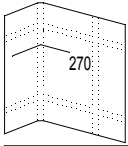

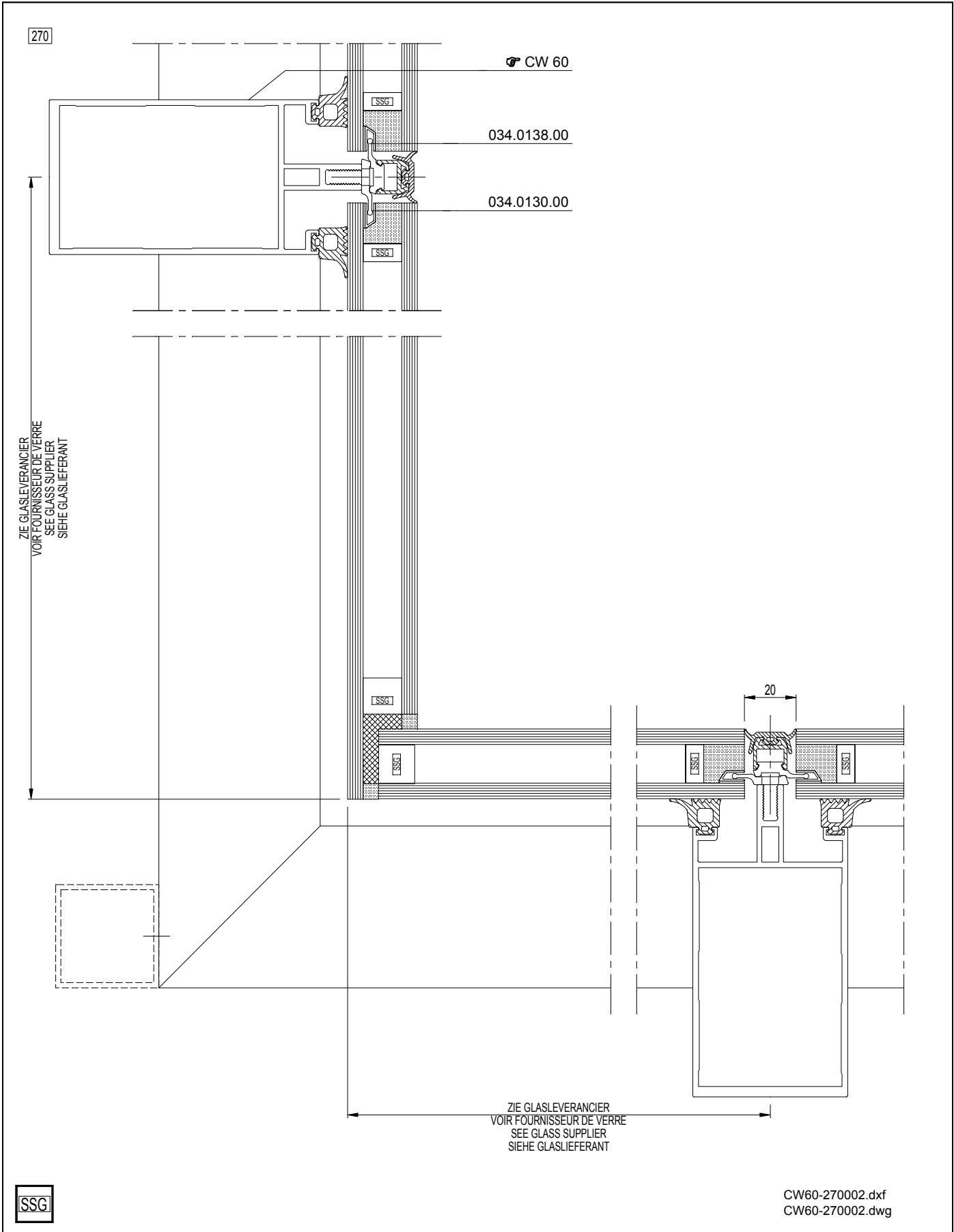
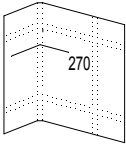

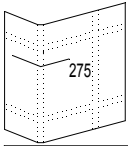

275

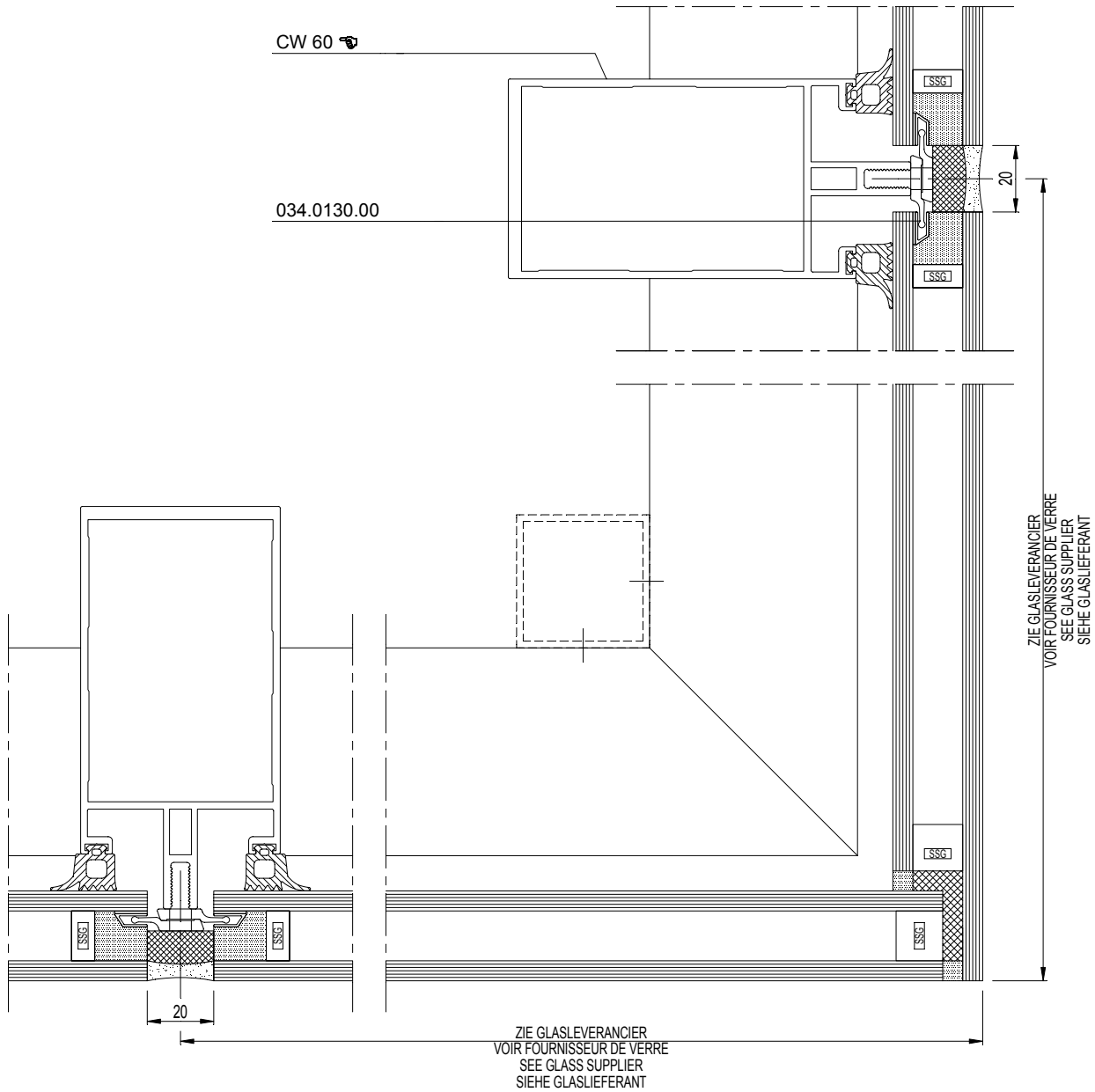

CW60-275001.dxf
CW60-275001.dwg



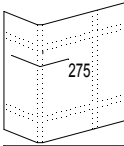

275

CW 60

034.0130.00

20

20

ZIE GLASLEVERANCIER
VOIR FOURNISSEUR DE VERRE
SEE GLASS SUPPLIER
SIEHE GLASLIEFERANT

ZIE GLASLEVERANCIER
VOIR FOURNISSEUR DE VERRE
SEE GLASS SUPPLIER
SIEHE GLASLIEFERANT

CW60-275002.dxf
CW60-275002.dwg



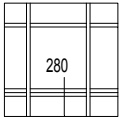

280

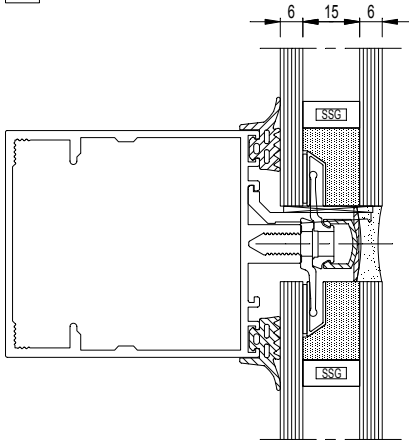

CW60-280001.dxf
CW60-280001.dwg

280

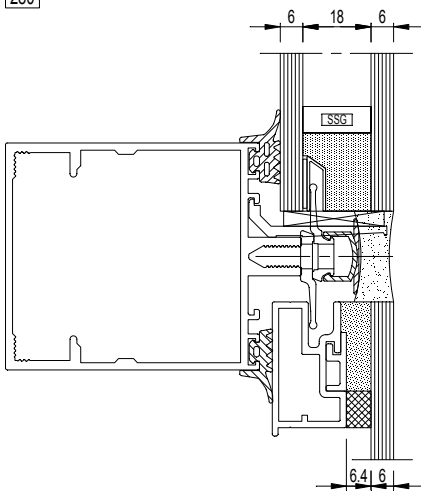

CW60-280002.dxf
CW60-280002.dwg

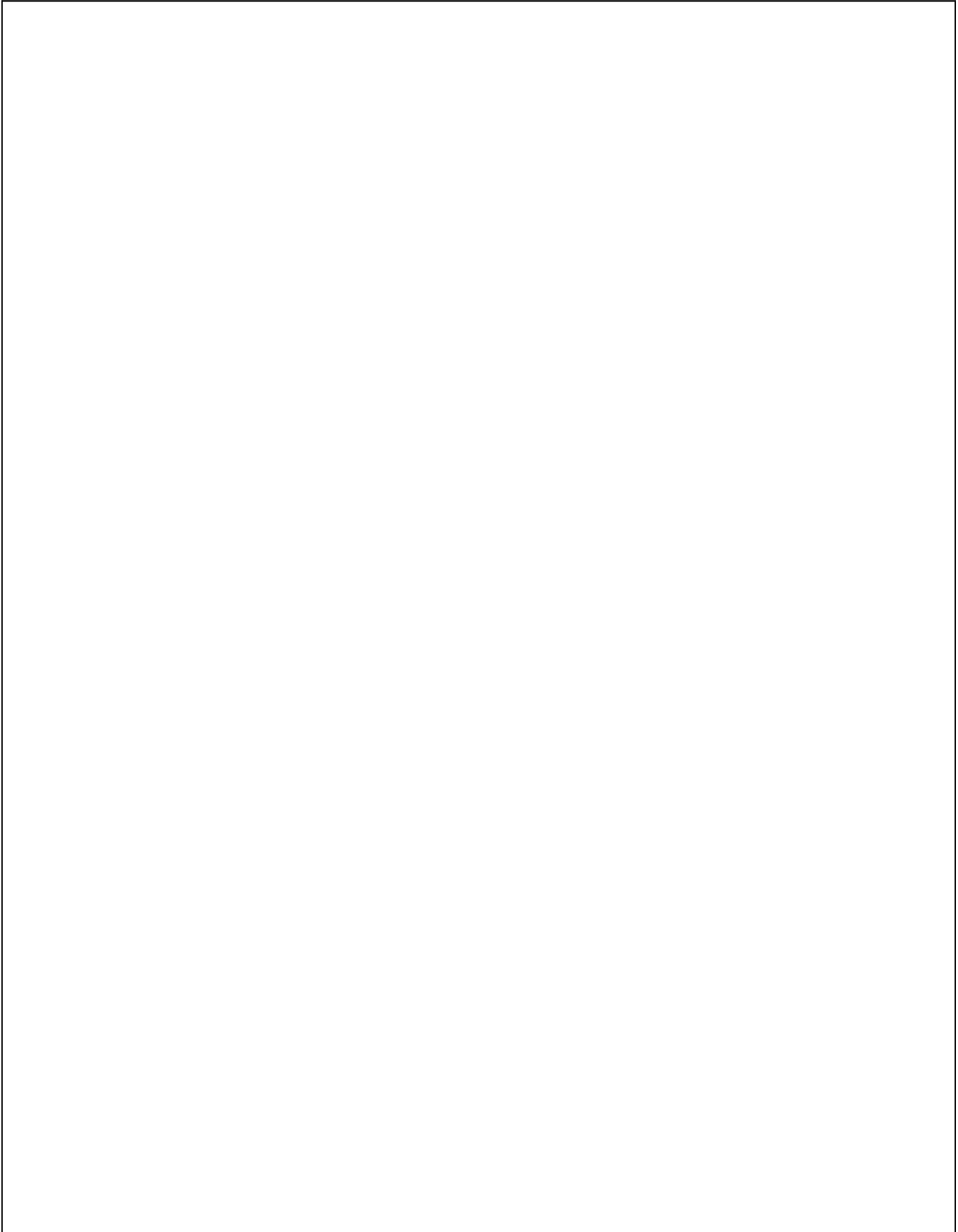

CW 60 Structural Glazing



1 Internal structure

Vertical internal structure

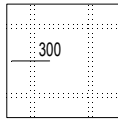

CW 60-SG - 302

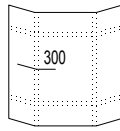

CW 60-SG - 302

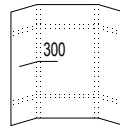

CW 60-SG - 302

Horizontal internal structure

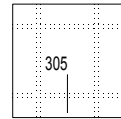

CW 60-SG - 303

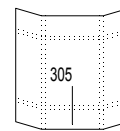

CW 60-SG - 303

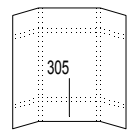

CW 60-SG - 303

2 Junction detail

Angle solutions

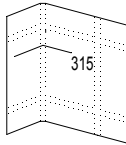

CW 60-SG - 310

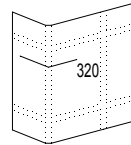

CW 60-SG - 311

Dilatation

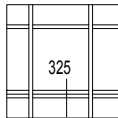

CW 60-SC - 313

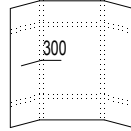
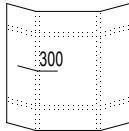
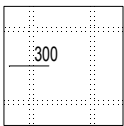

300

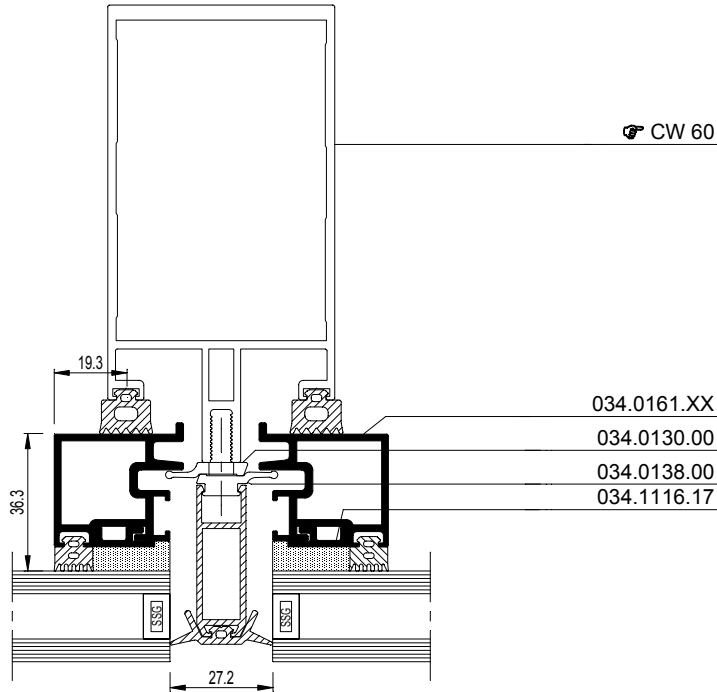

CW60-300001.dxf
 CW60-300001.dwg

300

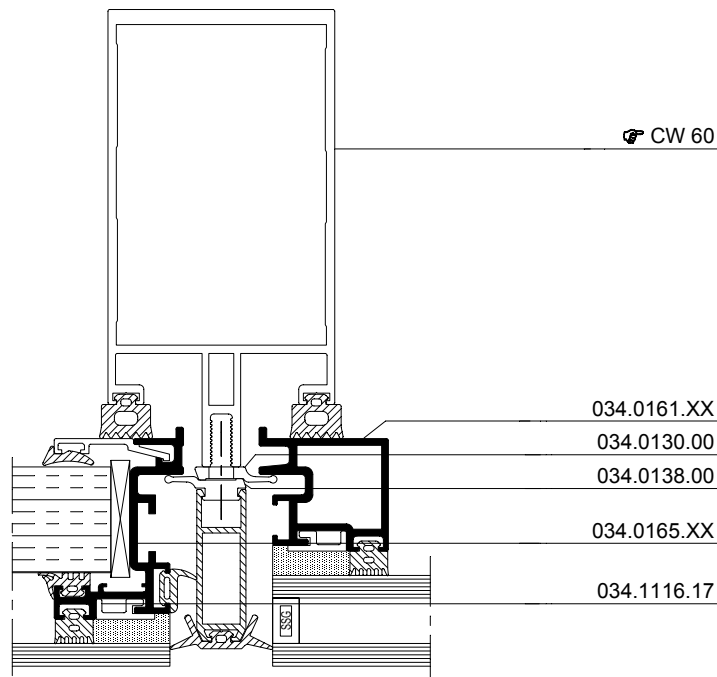

☞dxf
 ☞dwg

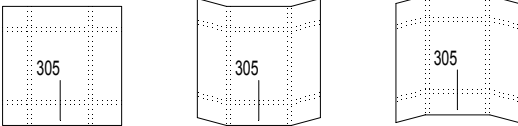

305

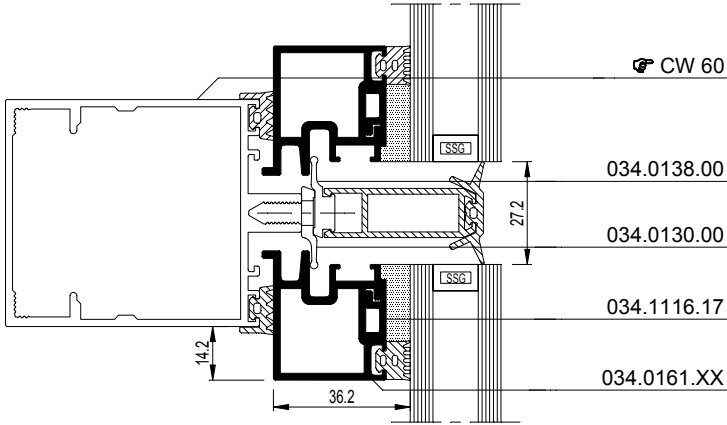

CW60-305001.dxf
 CW60-305001.dwg

305

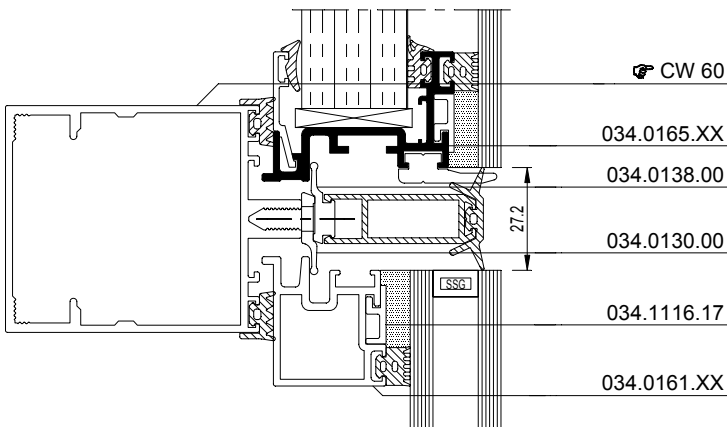

... .dxf
dwg

<p>034.0165.XX</p> <p>300 CW60-300002.dxf CW60-300002.dwg</p> <p>305 CW60-305002.dxf CW60-305002.dwg</p>	<p>034.0166.XX</p> <p>300 CW60-300003.dxf CW60-300003.dwg</p> <p>305 CW60-305003.dxf CW60-305003.dwg</p>
<p>034.0167.XX</p> <p>300 CW60-300004.dxf CW60-300004.dwg</p> <p>305 CW60-305004.dxf CW60-305004.dwg</p>	

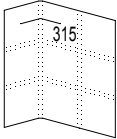

315

034.0161.XX

034.1116.17

27.2

☞ CW 60

ZIE GLASLEVERANCIER
VOIR FOURNISSEUR DE VERRE
SEE GLASS SUPPLIER
SIEHE GLASLIEFERANT

27.2

ZIE GLASLEVERANCIER
VOIR FOURNISSEUR DE VERRE
SEE GLASS SUPPLIER
SIEHE GLASLIEFERANT

CW60-315001.dxf
CW60-315001.dwg

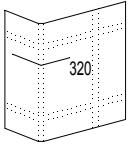

320

034.0116.XX

034.1116.17

CW 60

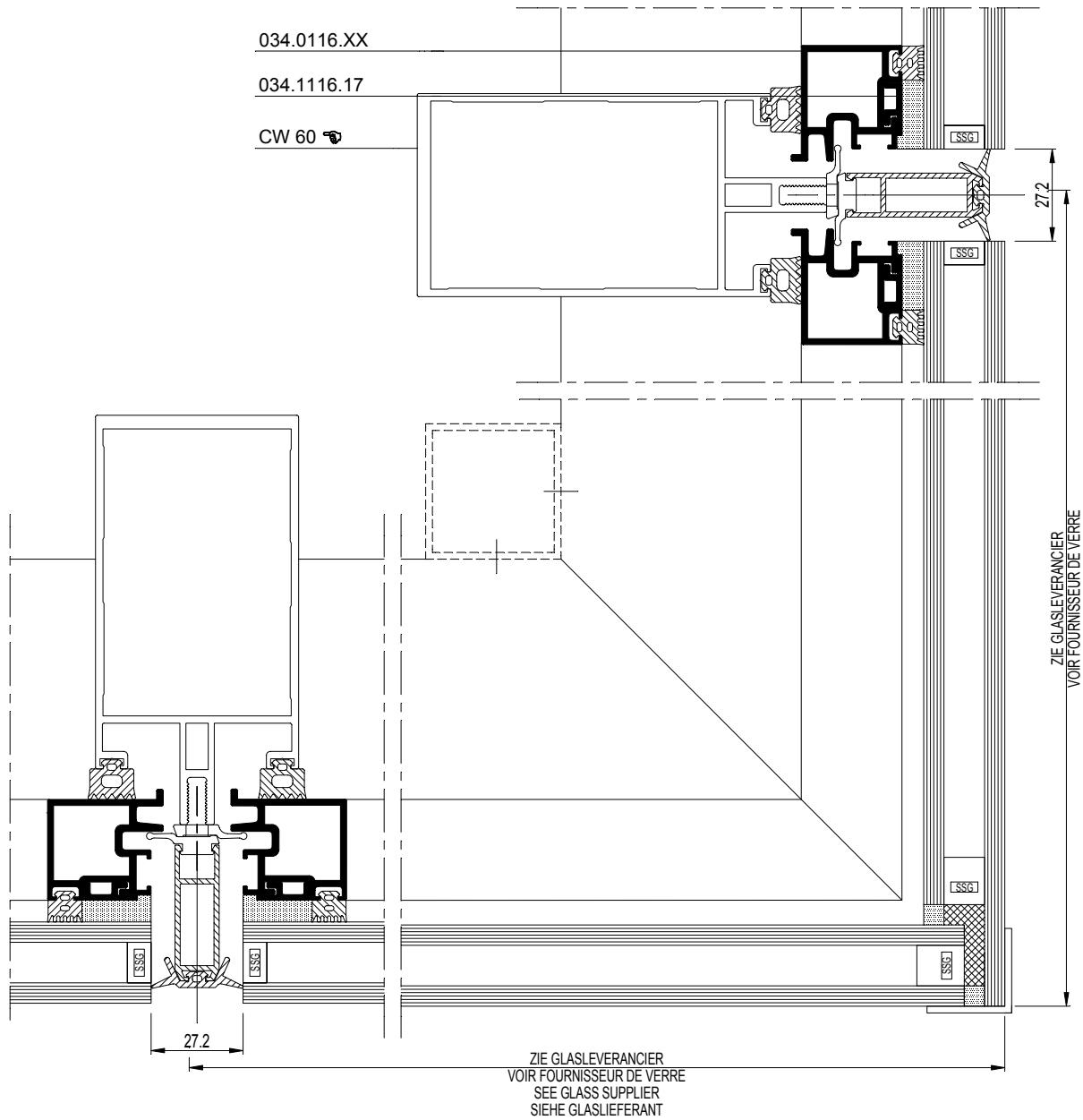

ZIE GLASLEVERANCIER
VOIR FOURNISSEUR DE VERRE
SEE GLASS SUPPLIER
SIEHE GLASLIEFERANT

ZIE GLASLEVERANCIER
VOIR FOURNISSEUR DE VERRE
SEE GLASS SUPPLIER
SIEHE GLASLIEFERANT

CW60-320001.dxf
CW60-320001.dwg

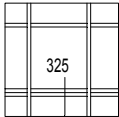

325

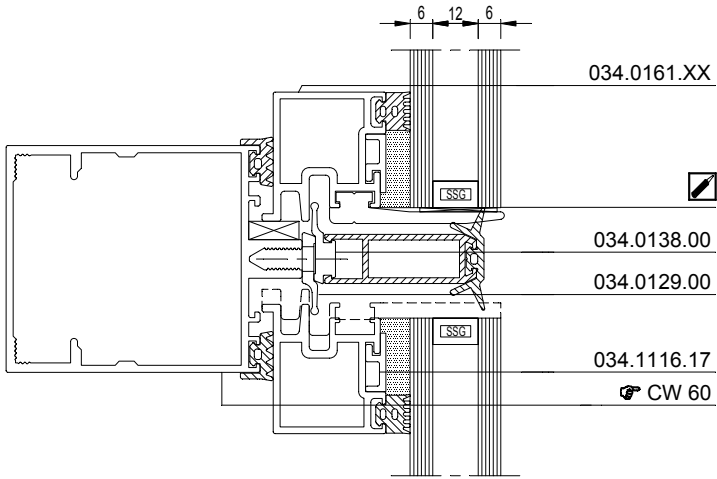

CW60-325001.dxf
CW60-325001.dwg